

L-force

Servo Drives 9400



Productive, economical, easy to use

Lenze

This is what we stand for.

You want to implement your machine and plant concepts efficiently and easily or optimise existing concepts to reduce costs? Then, Lenze is the partner you are looking for. For more than 60 years, drive and automation systems have been our core competence.



Drive and automation technology from Lenze keep things moving – for example in the areas of materials handling, robotics and component handling as well as in packaging facilities for the intralogistics and automotive sectors and the food and beverage industries.

Lenze | about us

We can offer you automation solutions including control, visualisation and drive technology from a single source. Our drive systems will improve the performance of your machines. From project planning to commissioning, we have the know-how, whilst our international sales and service network can provide you with expert help and advice at any time.

Cut your process costs and increase your ability to compete. Let us analyse your drive technology tasks and support you with made-to-measure solutions. We can take an integrated approach to projects thanks to the scalability of our products and the scope of the overall portfolio. We can get the best from your machines and systems.



At your side all over the world – with thorough and professional support from our motivated team.

L-force | Your future is our drive

L-force - your future is our drive

L-force is our new product philosophy introduced in response to the need to reduce costs, save time and increase efficiency. This generation of drive and automation technology sets innovation, flexibility, usability and system culture in perfect harmony.

L-force is innovation

In order to offer you more options and (added) value, we are constantly working to improve our solution still further.

L-force means flexibility

Performance, functional range, software, technical services and after-sales service - you get exactly the combination you need.

L-force means usability

Commissioning is made easier thanks to preconfigured solutions and simple, function-based engineering.

L-force means system

With L-force, everything is perfectly matched.

Let us help you shape your future.

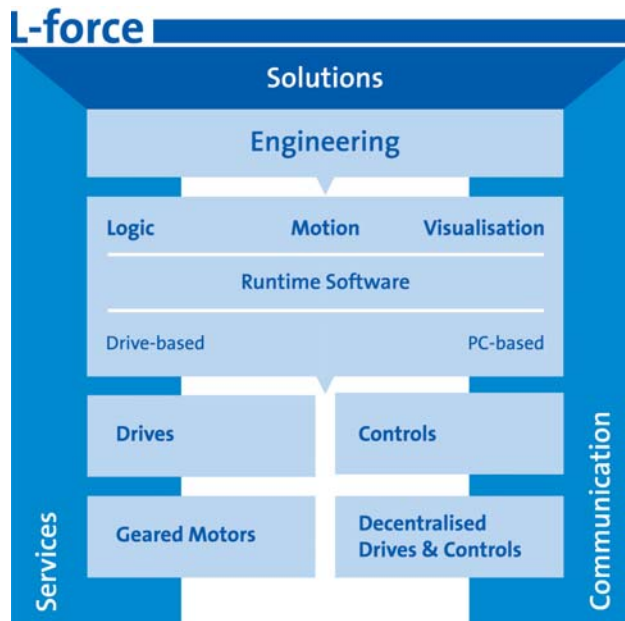

L-force is an integrated range of components, solutions, systems and technical services. The overview shows the overall portfolio along with the individual product/solution segments.

System overview | Servo Drives 9400

System overview

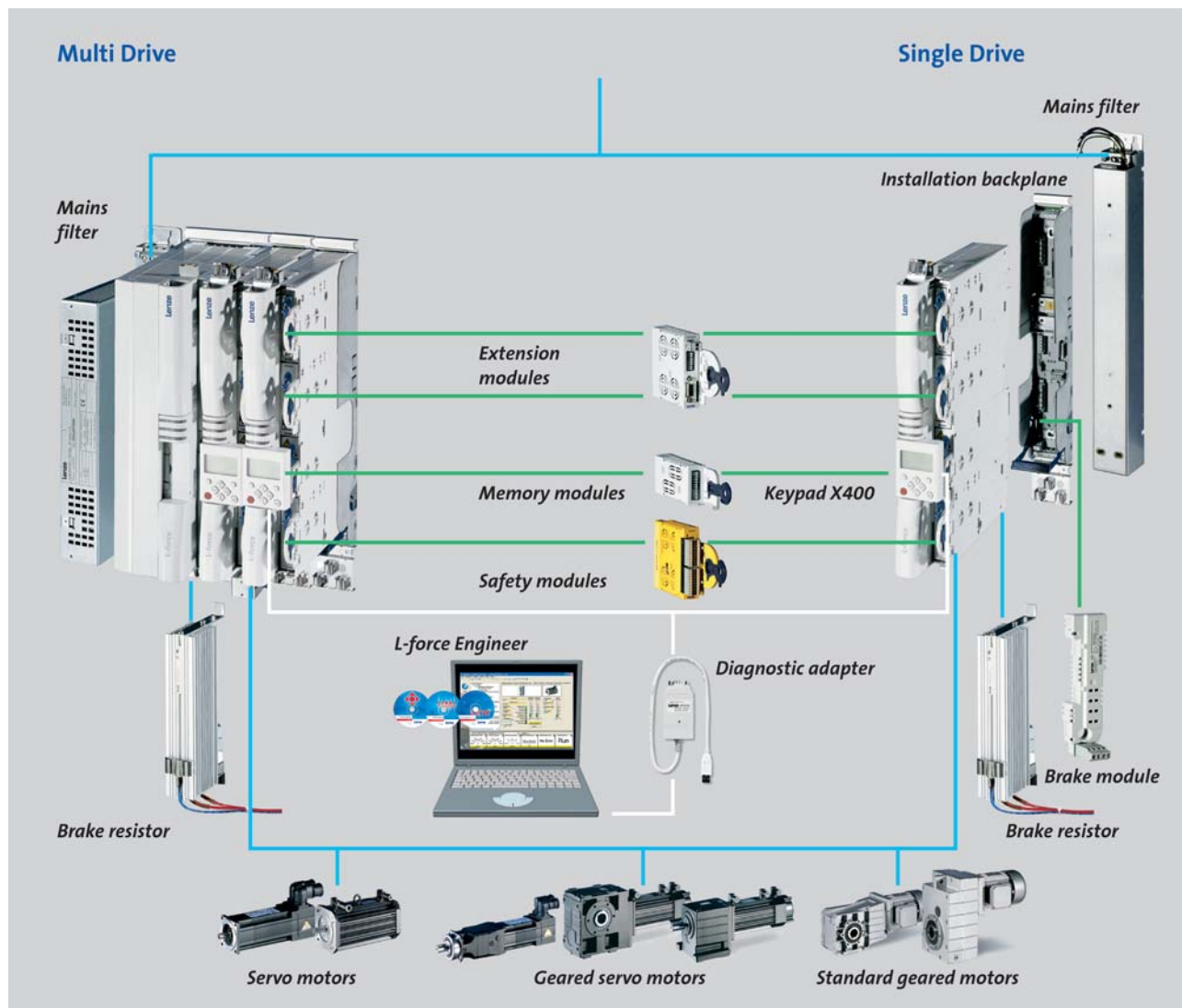

Other catalogues

This catalogue describes the Servo Drives 9400 and the accessories designed especially for this servo system. More components for the above system overview can be found in other catalogues. The automation components can be found in the Controller-based Automation and PC-based Automation catalogues.

You can find other components for a servo system in the following catalogues

- ▶ Servo Motors catalogue
- ▶ Geared Servo Motors catalogue
- ▶ Geared Motors catalogue

Overview | Servo Drives 9400

Selection and ordering 10



General information 16



Single Drive 28



Single Drive accessories 44



Multi Drive 56



Multi Drive accessories 66



Modules 78



Engineering software 102



Lenze world-wide 106



Contents | Servo Drives 9400



Selection and ordering

Product key	10
List of abbreviations	14
About this catalogue	15

General information

9400 Servo Drives Single Drive and Multi Drive	16
Servo Drives 9400 HighLine	17
Functions and features	18
Control connections	19
Power supply modules for 9400 Servo Drives	21
Functions and features	22
Control connections	23
Basic dimensioning of axis modules	24
Dimensioning for DC-bus operation	25
Standards and operating conditions	26

Single Drive

Rated data for Single Drives	28
------------------------------------	----

Single Drive accessories

Installation backplane	44
DC busbar set for Single Drive installation backplane	45
Brake modules	46
Brake resistors	48
Mains chokes	50
RFI and mains filters	52
Mains filter	53
Sinusoidal filter	54

Contents | Servo Drives 9400

Multi Drive

Rated data for Multi Drives	56
Rated data for power supply modules	62
Rated data for regenerative power supply modules	64

Multi Drive accessories

Installation backplane	66
Replacement DC fuses for Multi Drive installation backplane	67
Brake modules	68
DC input module	70
Brake resistors	71
RFI and mains filters	72
Mains filter	73

Accessories

24 V power supply unit	74
CAN bus connector	74
USB diagnostic adapter	75
Accessories for the USB diagnostic adapter	75
X400 keypad	76
Diagnosis terminal X400	76
Shield connection kits for motor cable	77
Other accessories	77

Modules

Overview of modules	78
Assignment of extension modules and module slots	81
Memory module	82
Safety module	84
Extension module: digital frequency	86
Communication module CANopen	88
Communication module DeviceNet	90
Communication module EtherCAT	92
Communication module Ethernet	94
Communication module ETHERNET Powerlink	96
ETHERNET Powerlink hub	97
Communication module PROFIBUS	98
Communication module PROFINET	100

L-force Engineer

General information	102
Functions and features	103
System requirements	104
Data access/communication	104
L-force Loader	104
Cam Designer	104
Overview of licences	105

Lenze world-wide

Lenze world-wide	106
------------------	-----



Servo Drives 9400

Selection and ordering

9400 Servo Drives product key

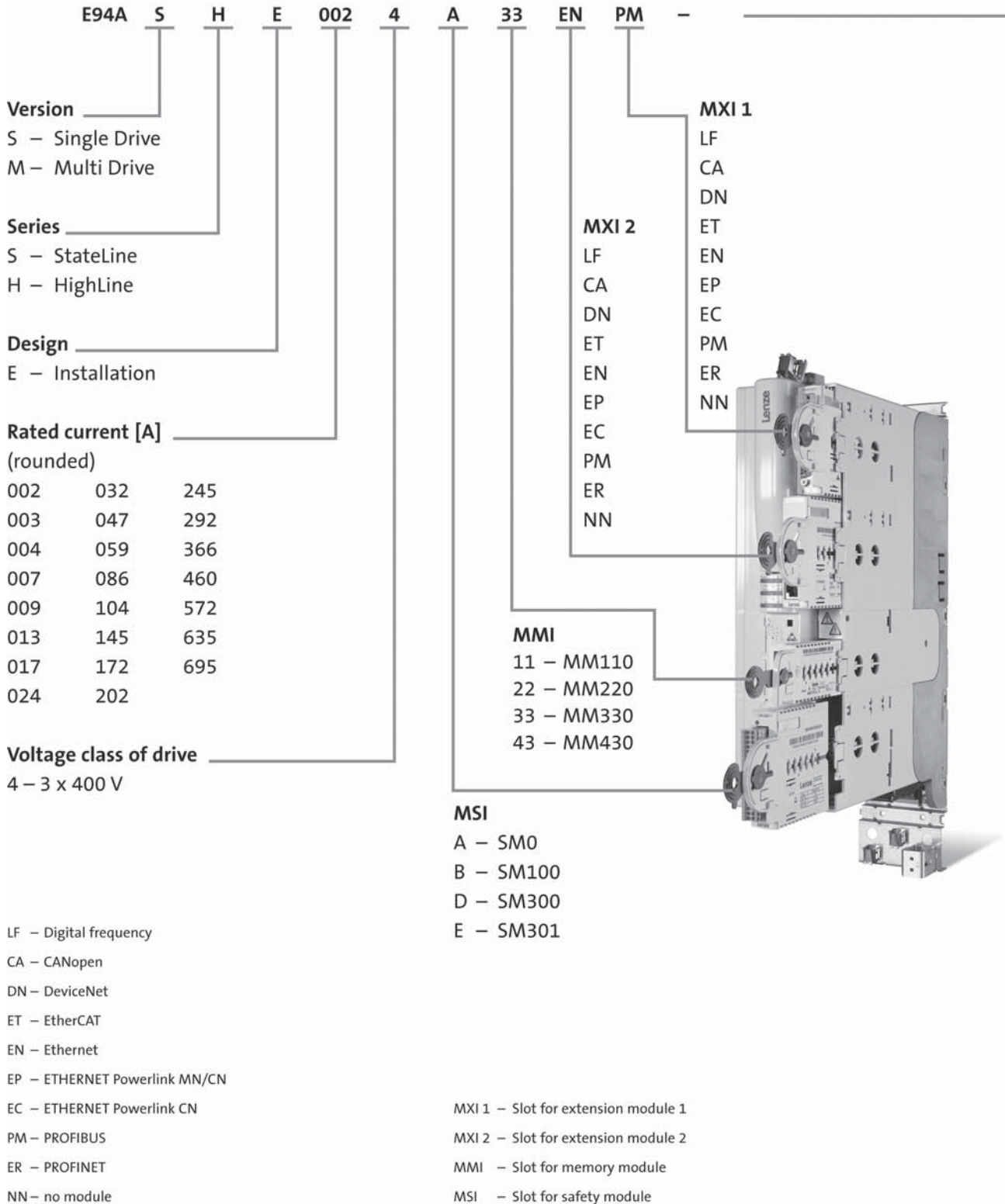

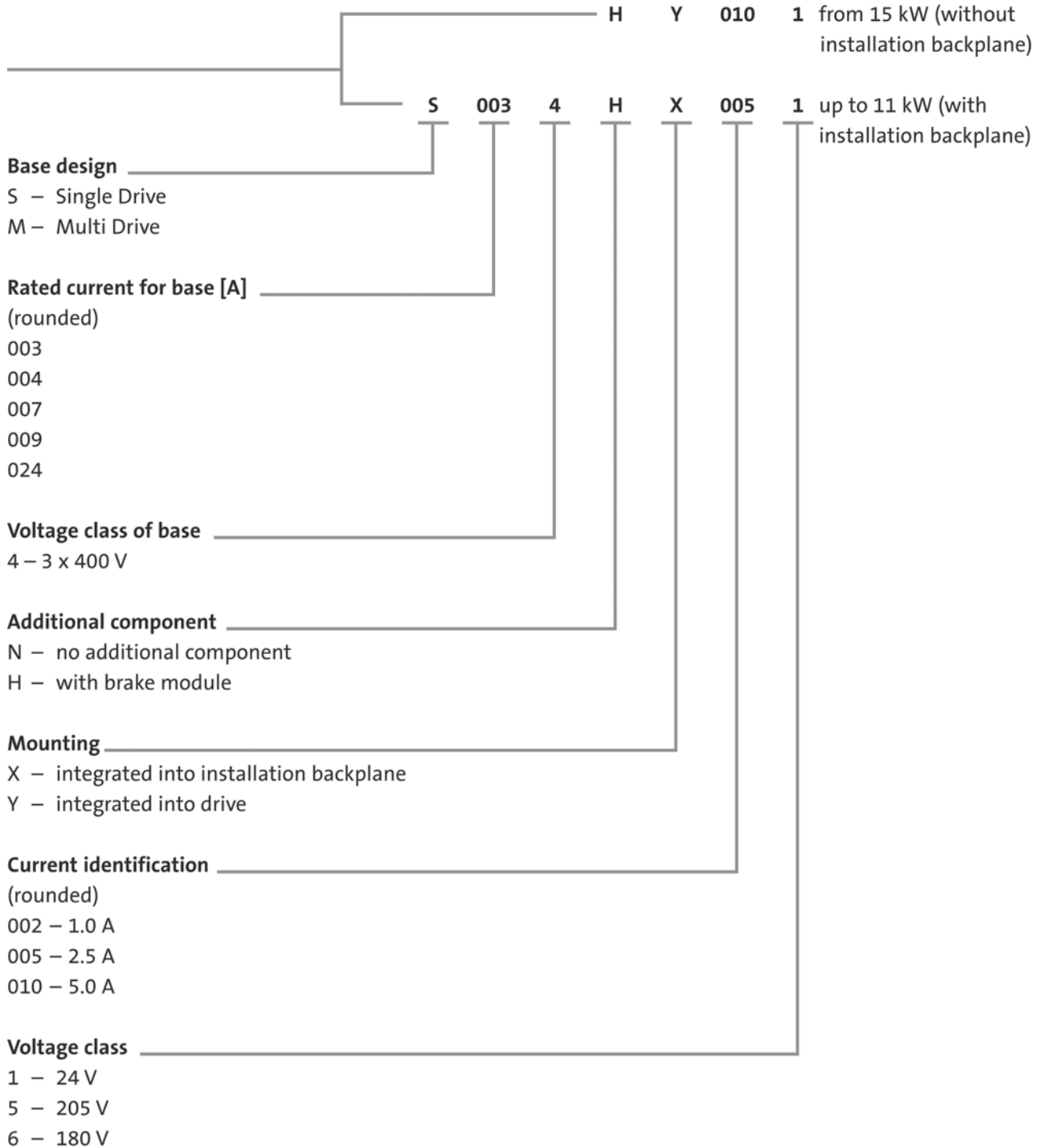



Servo Drives 9400

Selection and ordering

Product key: power supply modules and regenerative power supply modules for Servo Drives 9400

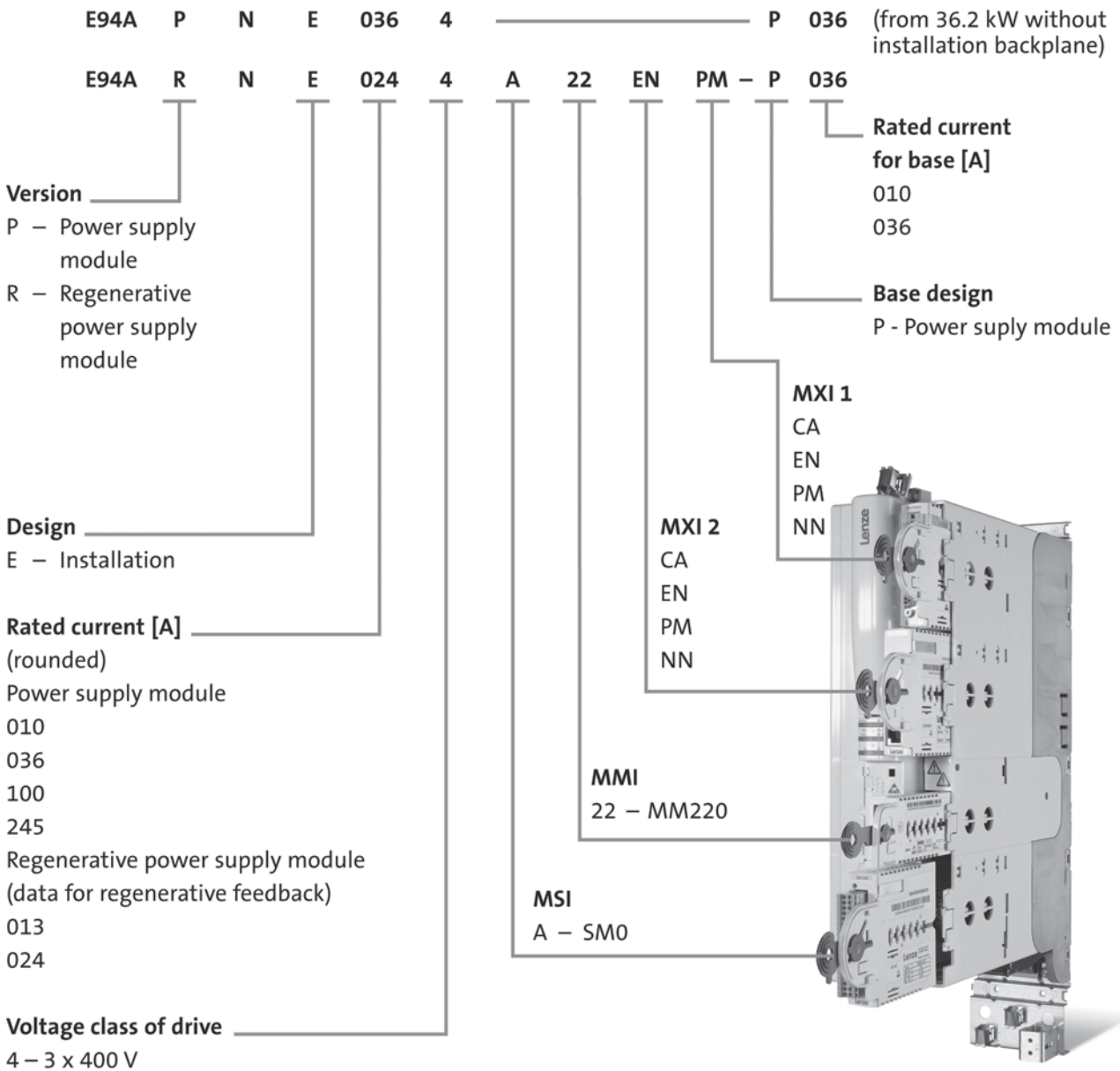

CA – CANopen
 EN – Ethernet
 PM – PROFIBUS
 NN – no module

MXI 1 – Slot for extension module 1
 MXI 2 – Slot for extension module 2
 MMI – Slot for memory module
 MSI – Slot for safety module





Servo Drives 9400

Selection and ordering

List of abbreviations

b	[mm]	Dimensions
C_{th}	[KW _s]	Thermal capacity
f_{ch}	[kHz]	Rated switching frequency
h	[mm]	Dimensions
i		Ratio
I_{N, out}	[A]	Rated output current
I_{N, AC}	[A]	Rated mains current
I_{N, DC}	[A]	Rated DC-bus current
I_{red, out}	[A]	Reduced output current
I_{red, DC}	[A]	Reduced DC-bus current
m	[kg]	Mass
n_{max}	[r/min]	Max. speed
P	[kW]	Typical motor power
P_N	[kW]	Rated power
P_{max}	[kW]	Max. output power
P_{max, 1}	[kW]	Max. output power
P_{max, 2}	[kW]	Max. short-time output power
P_V	[kW]	Power loss
R_N	[Ω]	Rated resistance
R_{min}	[Ω]	Min. brake resistance
t	[mm]	Dimensions
t_{ol}	[s]	Overload time
t_{on}	[s]	Run time
t_{re}	[s]	Recovery time
U	[V]	Voltage drop
U_{AC}	[V]	Mains voltage
U_{DC}	[V]	DC supply
U_{N, AC}	[V]	Rated voltage
U_{N, DC}	[V]	Rated voltage
U_{out}	[V]	Output voltage

DIAG	Slot for diagnostic adapter
DIN	Deutsches Institut für Normung e.V.
EN	European standard
EN 60529	Degrees of protection provided by enclosures (IP code)
EN 60721-3	Classification of environmental conditions; Part 3: Classes of environmental parameters and their limit values
EN 61800-3	Electrical variable speed drives Part 3: EMC requirements including special test methods
IEC 61131-2	Programmable logic controllers Part 2: Equipment and tests
IEC	International Electrotechnical Commission
IEC 61508	Functional safety of electrical/electronic/programmable electronic safety-related systems
IM	International Mounting Code
IP	International Protection Code
MMI	Modular memory interface (memory module)
MSI	Modular safety interface (safety module)
NEMA	National Electrical Manufacturers Association
UL	Underwriters Laboratory Listed Product
UR	Underwriters Laboratory Recognized Product
VDE	Verband deutscher Elektrotechniker (Association of German Electrical Engineers)



About this catalogue

This catalogue provides an overview of all the components in the 9400 Servo Drive product range. Here you can find the different axis modules (Single Drive and Multi Drive), the corresponding power supply modules, and all accessory components for a complete drive system. The same product range is also covered in the electronic DSC catalogue. The electronic catalogue is available on DVD and on the Internet at:

www.lenze.de/dsc

Additional information can also be downloaded from the Internet (e.g. rated data) for some components. These components are marked accordingly with the following arrow symbol and an identifier printed in bold.

→ Rated data for operation at 3/PE/AC 500 V
DS_9400_0001
Available for download at www.lenze.de/dsc

Just enter this identifier (e.g. **DS_9400_0001**) as the search term and you will get the information as a PDF file.

Inverters and accessories

All components of the 9400 Servo Drives range can be selected easily and quickly via a uniform product key.

To ensure clarity, similar device versions are indicated using a wildcard.

- ▶ The symbol □ represents all versions with the meaning indicated. For example, □ is used to combine the various versions, e.g.: E94AS□E0174, where □ is a wildcard for H (HighLine).
- ▶ The wildcards used with the mains filter or RFI filter accessories represent various rated currents.



Servo Drives 9400

General information

9400 Servo Drives Single Drive and Multi Drive

When will it click for you?

A great many technical achievements make our everyday lives easier.

Just like that, with one click

- ▶ the lights come on
- ▶ a seat belt engages
- ▶ you can surf the World Wide Web
- ▶ take a great photo of your family.

The 9400 Servo Drives will revolutionise your servo technology – with simple clicks.

Single Drive

Our single-axis drives combine mains supply, DC bus and inverter in a single drive. The filter elements and the brake chopper are integrated into the servo inverter and permit autonomous use in distributed control cabinet installations. Higher interference levels can be achieved without a larger mounting area by using suitable footprint filters (up to 55 kW).

Click – the new mounting concept

The Servo Drives 9400 stands out due to its revolutionary electromechanical mounting concept. The separation of installation backplane and drive electronics (up to 11 kW Single Drive, 15 kW Multi Drive) makes mounting, assembly and use much easier than in the case of any other comparable product.

Multi Drive

Our multi-axis drives are particularly suitable for centralised, compact multi-axis installations. The energy exchange via the DC bus reduces the power requirement on the mains side. The axes share the same mains supply, brake chopper and EMC filter. The parts requirements and installation work are thus significantly reduced. The integrated DC busbar system provides for compact installations for drives rated up to 15 kW.

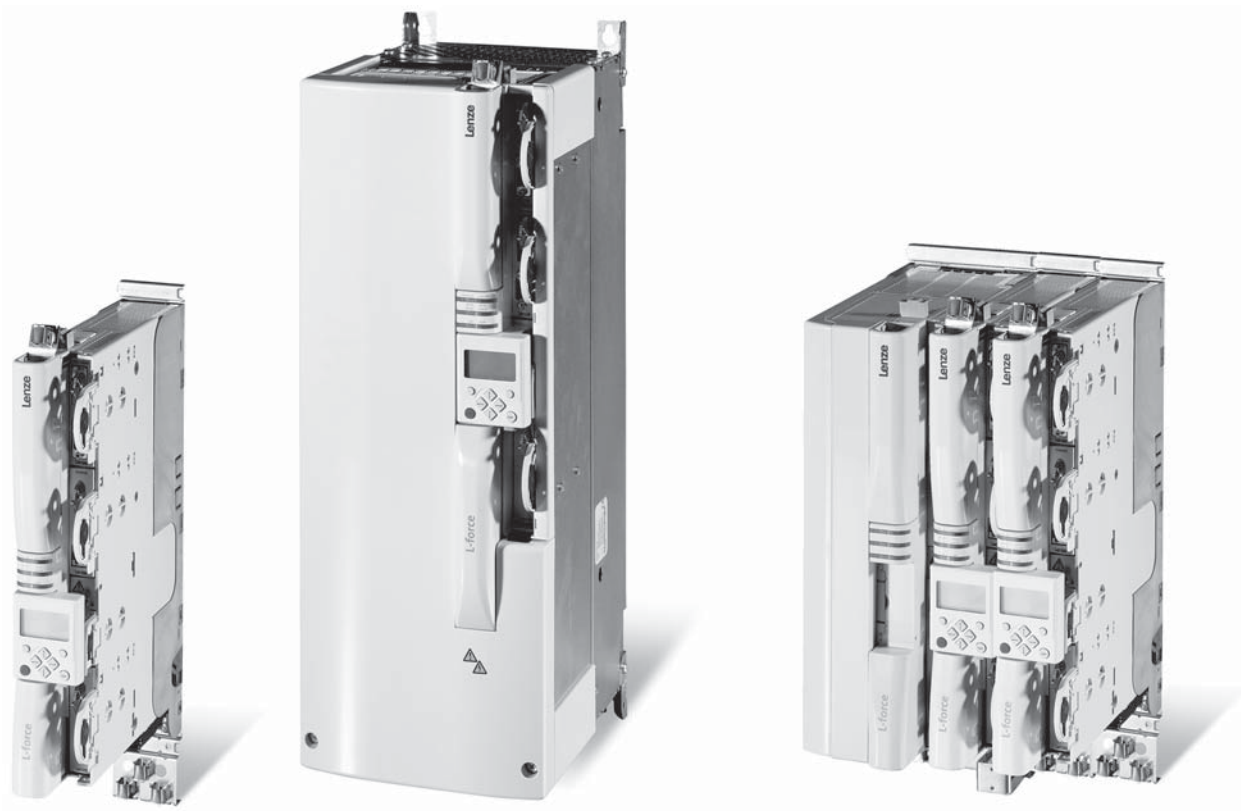

9400 Servo Drives Single Drive and 9400 Servo Drives Multi Drive



HighLine - for decentralised control concepts

The 9400 HighLine Servo Drives feature intelligence in the drive and are therefore designed for decentralised motion control applications as well as for centralised control topologies.

Lenze provides pre-programmed technology applications, e.g. table positioning, electronic gearbox and synchronism with mark registration for solving various applications simply by parameter setting. The function block editor integrated into the L-force Engineer HighLevel (PC setup tool) enables you to adapt the functions in an easy and flexible manner.

The HighLine Servo Drive comes with the CANopen fieldbus, conventional I/Os, diagnostic LEDs, a diagnostic interface, a resolver and a universal encoder input on board.

In addition, the HighLine is equipped with two extension slots for communication or extension modules as well as one slot each for a memory module and a safety module, so that the drive can be optimally adapted to your requirements.



Servo Drives 9400 HighLine



Servo Drives 9400

General information

Functions and features

Mode	Servo Drives 9400 HighLine
Control types, motor control	Field-oriented servo control (SC) for synchronous and asynchronous servo motors and standard asynchronous motors Sensorless vector control (SLVC) for standard asynchronous motors (for the drives: E94A□HE0024 to E94A□HE1044). V/f control (VFCplus) for standard and asynchronous servo motors
Basic functions	Motor control Drive monitoring and diagnostics Logbook, oscilloscope function Evaluation of electronic nameplate (ENP) for Lenze servo motors Speed, torque and position control Brake logic, homing, manual jog
Technology applications	Speed actuating drive Torque actuating drive Electronic gearbox Synchronism with mark registration Positioning (table positioning, positioning sequence control) Device profile DS402 IEC 61800-7-2: - Homing mode - Interpolated position mode - Cyclic synchronous position - Cyclic synchronous velocity - Cyclic synchronous torque
Advanced functions	Function blocks for cam function
Monitoring	Brake chopper, brake resistance Fan Motor phase failure DC-bus voltage
Monitoring and protective measures	Short circuit Short to earth (protected against short to earth during operation, limited protection against short to earth on mains power-up) Overvoltage Motor stalling, motor overload Overcurrent Overtemperature Undervoltage Motor overtemperature (input for PTC or thermal contact, I ² x t monitoring)
Diagnostics Diagnostic interface	Integrated For keypad or USB diagnostic adapter
Status display	6 LEDs
Braking operation Brake chopper Brake resistor	Integrated in Single Drives External



Control connections

Click – the modular structure

The pluggable control terminals of the Servo Drive 9400 are located on the front of the drive, making them easily accessible for control cabinet wiring. The USB diagnostic adapter E94AZCUS, keypad EZAEBK1001 and/or diagnosis terminal EZAEBK2001 are provided for the diagnostic interface. Prepared system cables for connecting the servo motors of the MCS, MCA and MQA series are used for feedback. These are available up to a cable length of 150 m.



Mode	Servo Drives 9400 HighLine
Analog inputs	
Number	2
Resolution	11 bits + sign
Value range	+/- 10V 1 x switchable 20mA
Analog outputs	
Number	2
Resolution	10 bits + sign
Value range	+/- 10V max. 2 mA
Digital inputs	
Number	8
Touch-probe-capable	8
Switching level	PLC (IEC 61131-2)
Max. input current	8 mA
Digital outputs	
Number	4
Switching level	PLC (IEC 61131-2)
Max. output current	50 mA
Load capacity	>480 Ω at 24 V



Servo Drives 9400

General information

Control connections

Mode	Servo Drives 9400 HighLine
Interfaces	
CANopen	Integrated
Extensions	Via slot MXI 1: extension 1 Via slot MXI 2: extension 2
State bus	Integrated
Memory	Slot MMI
Safety engineering	Slot MSI
Drive interface	
Resolver input	Sub-D, 9-pin Integrated
Encoder input	Multiple encoder input for: SinCos/TTL incremental encoder, SinCos absolute value encoder single-turn/multi-turn (HIPERFACE® / Endat V2.1) SSI encoder with Stegmann SSI protocol as position encoder or master encoder with minimum cycle time of 1 ms Sub-D, 15-pin
Motor temperature	Input on the device: PTC evaluation Via feedback: KTY evaluation
Motor brake	Optional, in installation backplane up to 32 A or in axis module from 32 A
External DC supply	
Rated voltage	24 V in accordance with IEC 61131-2
Voltage range	19.2 ... 28.8 V, max. residual ripple $\pm 5\%$
Current	Multi Drive: approx. 2.4 A during operation, max. 4 A starting current for 100 ms ¹⁾ Single Drive: approx. 1.2 A during operation, max. 3 A starting current for 100 ms

¹⁾ The supply voltage for the control electronics comes from the mains voltage. Alternatively, it can be provided by a 24 V supply that is independent of the mains (available as an option).



Power supply modules for 9400 Servo Drives

Power supply modules

The power supply modules for the 9400 series form the central AC mains connection for a Multi Drive axis module interconnection. They include an integrated brake chopper and a feeder to the DC busbar system for the 9400 Multi Drives. Filters and a brake resistor if required must be supplied by the customer.

The shared use of the mains supply, the mains filter, the brake chopper and the DC busbar system reduces the costs for materials and installation substantially within a Multi Drive axis layout.

Regenerative power supply modules

In a number of applications the electrical drives need to be accelerated and braked repeatedly. If the braking power generated by this operation is to be recovered into the mains, regenerative power supply modules can be used for this purpose.

The two models for rated supply powers of 15 kW and 27 kW fit seamlessly into the range of supply and axis modules. Installation and mounting are also very straightforward, thanks to the separation of the installation backplane and the electronic module. The required mains filter is simply mounted at the side and connected to the installation backplane and the regenerative power supply module via the available connecting cables. Mains filters come as standard models or with enhanced interference suppression for long motor cables.

Regenerative power supply modules can provide a multiple of their rated power for a short time, making them perfectly suited to intermittent drives. If a greater supply power is needed, other uncontrolled rectifiers can be connected in parallel, so these modules can be operated in parallel with a power supply module. If the regenerative power has to be increased, you can also simply connect other regenerative power supply modules in parallel.



Power supply module

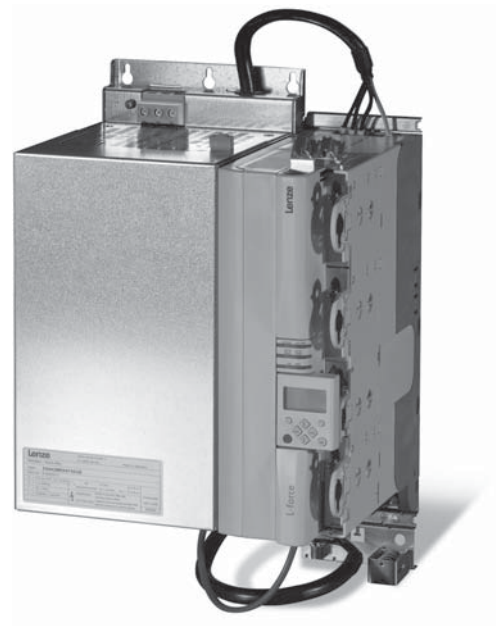

Supply-/regenerative module



Servo Drives 9400

General information

Functions and features

Mode	Power supply modules	Regenerative power supply modules
Basic functions	Supply to an axis module or multi-axis system in a DC-bus connection	Supply to an axis module or multi-axis system in a DC-bus connection Power recovery of the surplus power arising during braking operation into the mains Monitoring and diagnostics logbook, oscilloscope function
Advanced functions		Comprehensive function block library Integration of central open-loop and closed-loop control functions via custom-designed application
Monitoring	Brake chopper Mains voltage Overtemperature	Brake chopper, brake resistance Mains filter Mains voltage, DC-bus voltage Regenerative inverter Overtemperature
Monitoring and protective measures	Short circuit brake chopper	Short circuit brake chopper Mains and mains phase failure detection Overvoltage Undervoltage Device overload Mains filter overload Brake chopper overload Mains inverter overcurrent
Diagnostics		Integrated
Diagnostics interface		For keypad or USB diagnostic adapter
Status display	5 LEDs	6 LEDs
Braking operation		Via integrated mains inverter
Power recovery		
Brake chopper	Integrated	
Brake resistor	External	



Control connections

Click – the modular structure

The pluggable control connections of the power supply modules and the regenerative power supply modules are located at the front of the device to facilitate access to the control cabinet wiring. The USB diagnostic adapter E94AZCUS, the keypad EZAEBK1001 and the diagnosis terminal EZAEBK2001 are available for the diagnostic interface of the regenerative power supply module.



Mode	Power supply modules	Regenerative power supply modules
Analog inputs		
Number		2
Resolution		11 bits + sign
Value range		+/- 10V 1 x switchable 20mA
Analog outputs		
Number		2
Resolution		10 bits + sign
Value range		+/- 10V max. 2 mA
Digital inputs		
Number	1 Permanently configured	8
Switching level	PLC (IEC 61131-2)	
Max. input current	8 mA	
Digital outputs		
Number	4 Permanently configured	4
Switching level	PLC (IEC 61131-2)	
Max. output current	50 mA per output	
Load capacity	>480 Ω at 24 V	
Interfaces		
CANopen		Integrated
Extensions		Via slot MXI 1: extension 1 Via slot MXI 2: extension 2
State bus		Integrated
Memory		Slot MMI
Safety engineering		Slot MSI
Drive interface		
Resolver input		Integrated (no function)
Mains synchronisation input		Sub-D, 15-pin Integrated
External DC supply		
Rated voltage	24 V in accordance with IEC 61131-2	
Voltage range	19.2 ... 28.8 V, max. residual ripple ± 5%	
Current	Approx. 1.4 A during operation, max. 4 A starting current for 100 ms	Approx. 1.2 A during operation, max. 3 A starting current for 100 ms ¹⁾

¹⁾ The supply to the control electronics comes from the mains voltage. Alternatively, it can be provided by a 24 V supply that is independent of the mains (available as an option).



Servo Drives 9400

General information

Basic dimensioning of axis modules

The most important steps for dimensioning Single Drive and Multi Drive axis modules are listed here:

► **Motor power required**

First, the maximum torque required M_{max} , the maximum speed n_{max} , the effective torque M_{eff} and - for geared motors - the transmission ratio i are determined from the system data.

► **Motor selection**

Based on these values, the appropriate servo motor can be selected from the MCS (synchronous motors), MCA, MQA or MDFQA (asynchronous motors) ranges.

► **Selecting the axis module**

The axis modules are selected on the basis of the maximum currents and power required.

Depending on the drive, the 9400 Servo Drives and the power supply modules can be operated for overload time t_{ol} with maximum output current I_{max} , provided that the drive is then operated for recovery time t_{re} with a reduced output current.

The switching frequency is automatically adapted to the rate of utilisation.

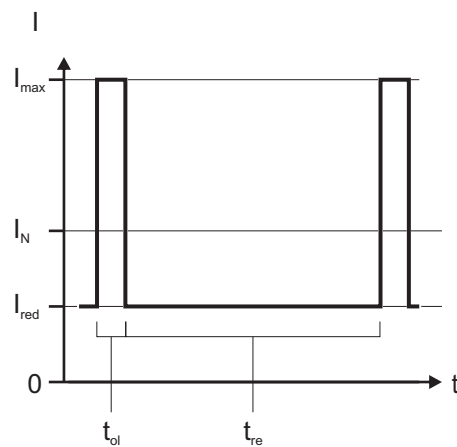

Maximum output current cycle

► **Braking operation**

If high moments of inertia are to be braked or if extended operation in generator mode is to be executed, braking energy can be transferred to an external brake resistor or converted into heat with Single Drive axis modules or with power supply modules via the integrated brake chopper.

The brake chopper can dissipate the continuous braking power P_N on a continual basis (case A) or the peak braking power P_{max} for the running time t_{on} followed by the recovery time t_{re} (case B).

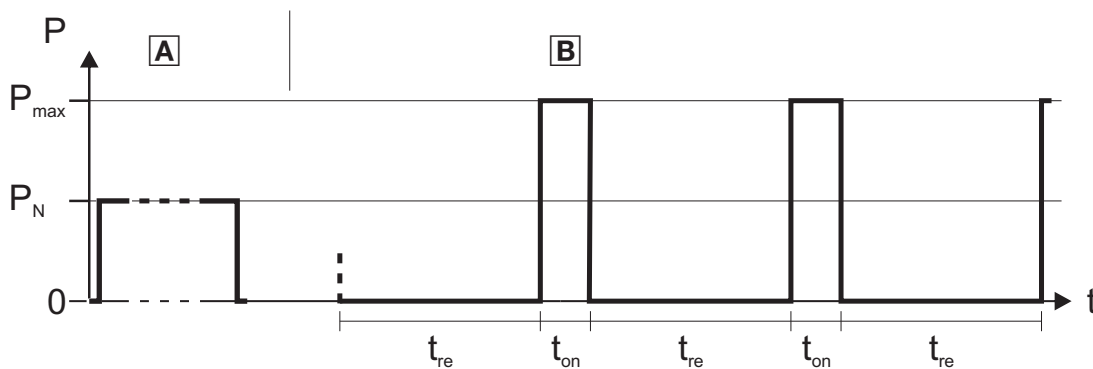

Brake chopper output power



Dimensioning for DC-bus operation

► Multi-axis module interconnection

The most effective way of determining the correct power supply module for a multi-axis application is if the time/power diagrams for the complete machine cycle are available for all axis modules. Adding together the isochronous individual performances gives the required gross performance and hence the minimum power of the power supply module. The necessary braking power or regenerative power can be determined in the same way.

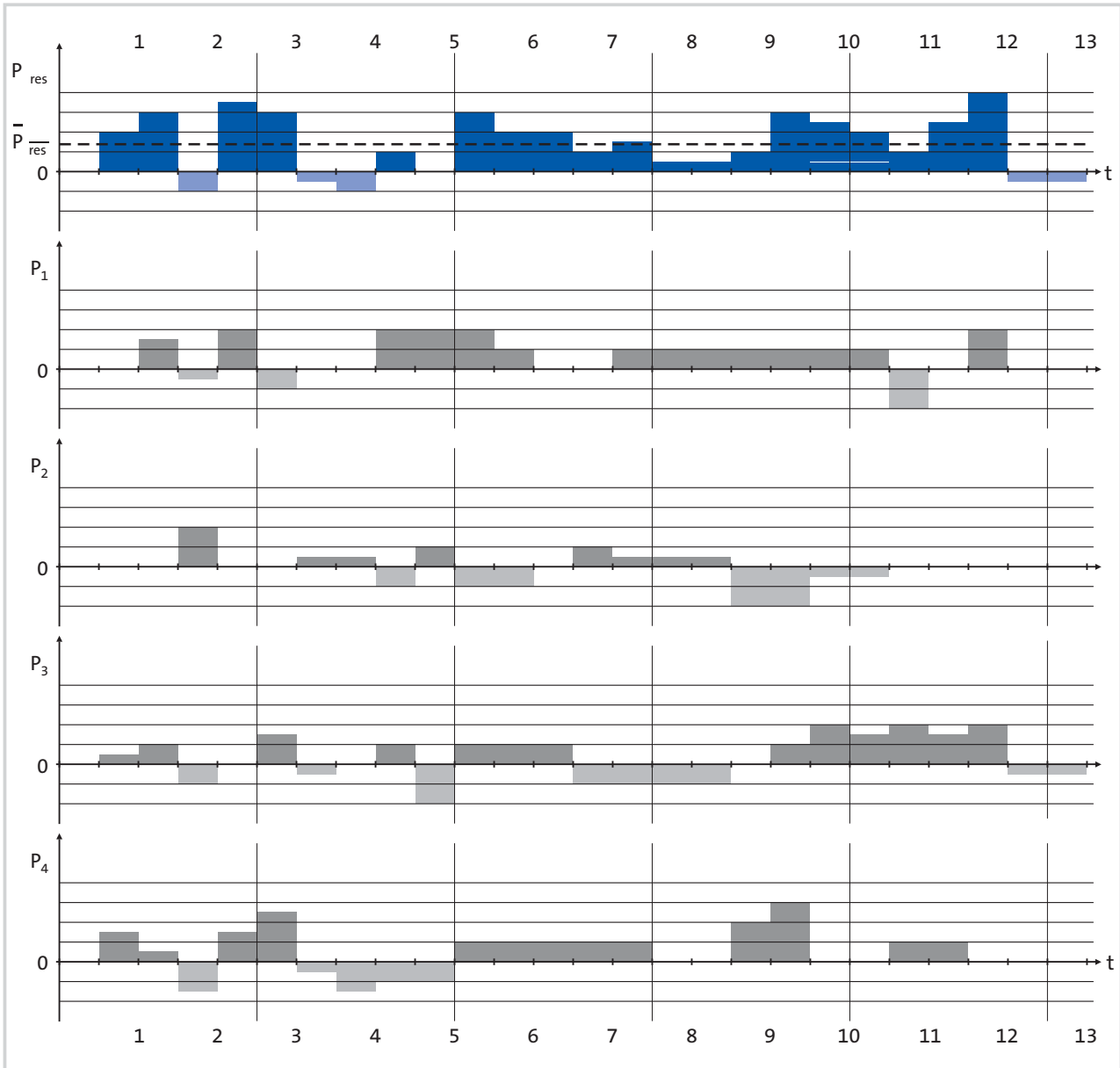

Time/power diagram of a multi-axis servo system
 $P_1 \dots P_4$ = individual power of axis 1...axis 4
 P_{res} = addition of individual powers
 $P_{res 1-4}$ = mean value of individual powers



Servo Drives 9400

General information

Standards and operating conditions

Conformity Type			CE: Low-Voltage Directive 2006/95/EC
Approval UL 508C			Power Conversion Equipment (file no. E132659) ¹⁾
Certification			GOST-R
Enclosure EN 60529 NEMA 250			IP20 ²⁾ Type 1
Climatic conditions Storage (EN 60721-3-1) Transport (EN 60721-3-2) Operation (EN 60721-3-3) Power reduction above 45 °C			1K3 (temperature: -25 °C ... +60 °C) 2K3 (temperature: -25 °C ... +70 °C) 3K3 (temperature: -10°C ... +55°C) 2.5% / K
Site altitude Amsl power reduction above 1000 m	H_{max}	[m] [%/1000 m]	4000 5.00
Vibration resistance Transport (EN 60721-3-2) Operation (Germanischer Lloyd)			2M2 5 Hz ≤ f ≤ 13.2 Hz ± 1 mm amplitude, 13.2 Hz ≤ f ≤ 100 Hz: 0.7 g

¹⁾ In preparation for the products: sinusoidal filters EZS3-180A200 to EZS3-480A200 and mains filters for regenerative power supply modules.

²⁾ Not in the wire range of the on the motor-side terminals

Supply form			Systems with earthed star point (TN and TT systems) Systems with high-resistance or isolated star point (IT systems)
Discharge current to PE EN 61800-5-1	I	[mA]	> 3.5 mA, fixed installation required, PE must be reinforced
Noise emission EN 61800-3			Cable-guided disturbance: E94AS□E0024 to E94AS□E0244: 10 m E94AS□E0324 to E94AS□E1044: 50 m Cable-guided disturbance: Max. shielded motor cable lengths for compliance with EMC protection requirement C2 without external filters
Noise immunity EN 61800-3			Category C3
Insulation resistance EN 61800-5-1			Above 2000 m amsl overvoltage category II Overvoltage category III
Degree of pollution EN 61800-5-1			2
Protective insulation of control circuits EN 61800-5-1			for digital inputs and outputs Safe mains isolation: double/reinforced insulation









Servo Drives 9400

Single Drive

Rated data for Single Drives

► The data is valid for operation at 3/PE 400 V AC or 565 V DC. Unless otherwise specified, the data refers to the default setting.

► Rated data for operation at 3/PE/AC 500 V
DS_9400_0001
 Available for download at www.lenze.de/dsc

						
Typical motor power 4-pole asynchronous motor	P	[kW]	0.37	0.75	1.50	3.00
Product key ¹⁾ Single Drive			E94AS□E0024	E94AS□E0034	E94AS□E0044	E94AS□E0074
Mains voltage range	U _{AC}	[V]	3/PE AC 180 V-0 % ... 550 V+0 %, 45 Hz-0 % ... 65 Hz+0 %			
Rated mains current With mains choke	I _{N, AC}	[A]	1.5	2.5	3.9	7.0
Without mains choke	I _{N, AC}	[A]	2.1	3.5	5.5	9.9
Rated output current	I _{N, out}	[A]	1.5	2.5	4.0	7.0
Rated switching frequency	f _{ch}	[kHz]	8			
Output current 2 kHz	I _{out}	[A]	1.9 ³⁾	3.1 ³⁾	5.0 ³⁾	8.8 ³⁾
4 kHz	I _{out}	[A]	1.9 ³⁾	3.1 ³⁾	5.0 ³⁾	8.8 ³⁾
8 kHz	I _{out}	[A]	1.5	2.5	4.0	7.0
16 kHz	I _{out}	[A]	1.1	1.9	3.0	5.3

Rated data for 60 s overload

Max. output current ^{2, 4)}	I _{max, out}	[A]	2.8	4.7	7.5	13.1
Reduced output current ^{2, 4)}	I _{red, out}	[A]	1.4	2.3	3.8	6.6
Overload time ^{2, 4)}	t _{ol}	[s]	60.0			
Recovery time ^{2, 4)}	t _{re}	[s]	120.0			

Rated data for 0.5 s overload

Max. short-time output current ^{2, 4)}	I _{max, out}	[A]	6.0	10.0	16.0	21.0
Reduced output current ^{2, 4)}	I _{red, out}	[A]	1.4	2.3	3.8	6.6
Overload time ^{2, 4)}	t _{ol}	[s]	0.5			
Recovery time ^{2, 4)}	t _{re}	[s]	4.5			

1) →  10 - See product key

2) →  24 - See diagram

3) Operation only permitted with mains choke or mains filter





4) Mains filter necessary. Without a mains filter, the indicated values for I_{max} and I_{red} decrease



Rated data for Single Drives

▶ The data is valid for operation at 3/PE 400 V AC or 565 V DC. Unless otherwise specified, the data refers to the default setting.

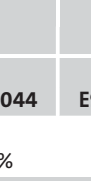
➔ Rated data for operation at 3/PE/AC 500 V
DS_9400_0001
 Available for download at www.lenze.de/dsc

						
Typical motor power 4-pole asynchronous motor	P	[kW]	0.37	0.75	1.50	3.00
Product key ¹⁾ Single Drive			E94AS□E0024	E94AS□E0034	E94AS□E0044	E94AS□E0074
DC supply	U_{DC}	[V]	DC 260 V -0 % ... 775 V +0 %			
Rated DC-bus current	I_{N,DC}	[A]	2.6	4.3	6.7	12.1
Power loss	P_V	[W]	110	130	160	210
Dimensions						
Height	h	[mm]		350		
Height, including fastening	h	[mm]		481		
Width	b	[mm]	60		90	
Depth	t	[mm]		288		
Mass	m	[kg]	4.0		5.3	
Max. cable length						
shielded C1 with external measures	I_{max}	[m]		25		
shielded C2 without external measures	I_{max}	[m]		10		
shielded C2 with external measures	I_{max}	[m]	50		100	

Brake chopper rated data

Rated power, Brake chopper ²⁾	P_N	[kW]	1.30	1.90	2.60
Max. output power, Brake chopper ²⁾	P_{max,1}	[kW]	6.4	11.2	
Running time ²⁾	t_{on}	[s]	0.7	0.6	0.8
Recovery time ²⁾	t_{re}	[s]	4.3	4.4	4.2
Min. brake resistance ²⁾	R_{min}	[Ω]	82.0	47.0	

¹⁾ ➔  10 - See product key

²⁾ ➔  24 - See diagram



Servo Drives 9400

Single Drive

Rated data for Single Drives

► The data is valid for operation at 3/PE 400 V AC or 565 V DC. Unless otherwise specified, the data refers to the default setting.

→ Rated data for operation at 3/PE/AC 500 V
DS_9400_0001

Available for download at www.lenze.de/dsc



			5.50	7.50	11.0
Typical motor power 4-pole asynchronous motor	P	[kW]	5.50	7.50	11.0
Product key ¹⁾ Single Drive			E94AS□E0134	E94AS□E0174	E94AS□E0244
Mains voltage range	U_{AC}	[V]	3/PE AC 180 V-0 % ... 550 V+0 %, 45 Hz-0 % ... 65 Hz+0 %		
Rated mains current With mains choke	I_{N, AC}	[A]	11.8	15.0	20.5
Without mains choke	I_{N, AC}	[A]	16.8	21.0	29.0
Rated output current	I_{N, out}	[A]	13.0	16.5	23.5
Rated switching frequency	f_{ch}	[kHz]	8		
Output current 2 kHz	I_{out}	[A]	16.3 ³⁾	20.6 ³⁾	29.4 ³⁾
4 kHz	I_{out}	[A]	16.3 ³⁾	20.6 ³⁾	29.4 ³⁾
8 kHz	I_{out}	[A]	13.0	16.5	23.5
16 kHz	I_{out}	[A]	9.8	12.4	17.6

Rated data for 60 s overload

Max. output current ^{2, 4)}	I_{max, out}	[A]	24.4	30.9	44.1
Reduced output current ^{2, 4)}	I_{red, out}	[A]	12.2	15.5	22.1
Overload time ^{2, 4)}	t_{ol}	[s]	60.0		
Recovery time ^{2, 4)}	t_{re}	[s]	120.0		

Rated data for 0.5 s overload

Max. short-time output current ^{2, 4)}	I_{max, out}	[A]	39.0	49.5	58.8
Reduced output current ^{2, 4)}	I_{red, out}	[A]	12.2	15.5	22.1
Overload time ^{2, 4)}	t_{ol}	[s]	0.5		
Recovery time ^{2, 4)}	t_{re}	[s]	4.5		

1) → 10 - See product key

2) → 24 - See diagram

3) Operation only permitted with mains choke or mains filter

4) Mains filter necessary. Without a mains filter, the indicated values for I_{max} and I_{red} decrease



Rated data for Single Drives

▶ The data is valid for operation at 3/PE 400 V AC or 565 V DC. Unless otherwise specified, the data refers to the default setting.

→ Rated data for operation at 3/PE/AC 500 V
DS_9400_0001
 Available for download at www.lenze.de/dsc

Typical motor power 4-pole asynchronous motor	P	[kW]	5.50	7.50	11.0
Product key ¹⁾ Single Drive			E94AS□E0134	E94AS□E0174	E94AS□E0244
DC supply	U_{DC}	[V]	DC 260 V -0 % ... 775 V +0 %		
Rated DC-bus current	I_{N,DC}	[A]	20.6	25.7	35.5
Power loss	P_V	[W]	320	380	500
Dimensions					
Height	h	[mm]		350	
Height, including fastening	h	[mm]		481	
Width	b	[mm]		120	
Depth	t	[mm]		288	
Mass	m	[kg]		8.1	
Max. cable length					
shielded C1 with external measures	I_{max}	[m]		25	
shielded C2 without external measures	I_{max}	[m]		10	
shielded C2 with external measures	I_{max}	[m]		100	

Brake chopper rated data

Rated power, Brake chopper ²⁾	P_N	[kW]	4.70	6.40	9.30
Max. output power, Brake chopper ²⁾	P_{max,1}	[kW]	19.5	29.2	
Running time ²⁾	t_{on}	[s]	0.8	0.7	1.1
Recovery time ²⁾	t_{re}	[s]	4.2	4.3	3.9
Min. brake resistance ²⁾	R_{min}	[Ω]	27.0	18.0	

¹⁾ → 10 - See product key

²⁾ → 24 - See diagram



Servo Drives 9400

Single Drive

Rated data for Single Drives

► The data is valid for operation at 3/PE 400 V AC or 565 V DC. Unless otherwise specified, the data refers to the default setting.

→ Rated data for operation at 3/PE/AC 500 V
DS_9400_0001
 Available for download at www.lenze.de/dsc



			15.0	22.0	30.0
Typical motor power 4-pole asynchronous motor	P	[kW]	15.0	22.0	30.0
Product key ¹⁾ Single Drive			E94AS□E0324	E94AS□E0474	E94AS□E0594
Mains voltage range	U_{AC}	[V]	3/PE AC 180 V-0 % ... 550 V+0 %, 45 Hz-0 % ... 65 Hz+0 %		
Rated mains current With mains choke	I_{N, AC}	[A]	29.0	43.0	54.0
Without mains choke	I_{N, AC}	[A]	29.0	43.0	54.0
Rated output current	I_{N, out}	[A]	32.0	47.0	59.0
Rated switching frequency	f_{ch}	[kHz]	8	4	
Output current 2 kHz	I_{out}	[A]	38.4	47.0	59.0
4 kHz	I_{out}	[A]	38.4	47.0	59.0
8 kHz	I_{out}	[A]	32.0		41.0
16 kHz	I_{out}	[A]	16.8		21.5

Rated data for 60 s overload

Max. output current ²⁾	I_{max, out}	[A]	57.6	70.5	88.5
Reduced output current ²⁾	I_{red, out}	[A]	28.8	35.3	44.3
Overload time ²⁾	t_{ol}	[s]		60.0	
Recovery time ²⁾	t_{re}	[s]		120.0	

Rated data for 0.5 s overload

Max. short-time output current ²⁾	I_{max, out}	[A]	76.8	94.0	118.0
Reduced output current ²⁾	I_{red, out}	[A]	28.8	35.3	44.3
Overload time ²⁾	t_{ol}	[s]		0.5	
Recovery time ²⁾	t_{re}	[s]		4.5	

1) → 10 - See product key

2) → 24 - See diagram



Rated data for Single Drives

▶ The data is valid for operation at 3/PE 400 V AC or 565 V DC. Unless otherwise specified, the data refers to the default setting.

→ Rated data for operation at 3/PE/AC 500 V
DS_9400_0001
 Available for download at www.lenze.de/dsc

					
Typical motor power 4-pole asynchronous motor	P	[kW]	15.0	22.0	30.0
Product key ¹⁾ Single Drive			E94AS□E0324	E94AS□E0474	E94AS□E0594
DC supply	U_{DC}	[V]	DC 260 V -0 % ... 775 V +0 %		
Rated DC-bus current	I_{N,DC}	[A]	36.0	53.0	66.0
Power loss	P_V	[W]	700	1050	1122
Dimensions					
Height	h	[mm]		556	
Height, including fastening	h	[mm]		606	
Width	b	[mm]		206	
Depth	t	[mm]		294	
Mass	m	[kg]		26.5	
Max. cable length					
shielded C1 with external measures	I_{max}	[m]		50	
shielded C2 without external measures	I_{max}	[m]		50	
shielded C2 with external measures	I_{max}	[m]		100	

Brake chopper rated data

Rated power, Brake chopper ²⁾	P_N	[kW]	12.6	18.6	25.3
Max. output power, Brake chopper ²⁾	P_{max,1}	[kW]	29.2	35.0	
Running time ²⁾	t_{on}	[s]	260.0	320.0	430.0
Recovery time ²⁾	t_{re}	[s]	340.0	280.0	170.0
Min. brake resistance ²⁾	R_{min}	[Ω]	18.0	15.0	

¹⁾ →  10 - See product key

²⁾ →  24 - See diagram



Servo Drives 9400

Single Drive

Rated data for Single Drives

► The data is valid for operation at 3/PE 400 V AC or 565 V DC. Unless otherwise specified, the data refers to the default setting.

→ Rated data for operation at 3/PE/AC 500 V
DS_9400_0001
 Available for download at www.lenze.de/dsc



Typical motor power 4-pole asynchronous motor	P	[kW]	45.0	55.0
Product key ¹⁾ Single Drive			E94AS□E0864	E94AS□E1044
Mains voltage range	U_{AC}	[V]	3/PE AC 180 V-0 % ... 550 V+0 %, 45 Hz-0 % ... 65 Hz+0 %	
Rated mains current With mains choke	I_{N, AC}	[A]	79.0	95.0
Without mains choke	I_{N, AC}	[A]	79.0	95.0
Rated output current	I_{N, out}	[A]	86.0	104.0
Rated switching frequency	f_{ch}	[kHz]	4	
Output current 2 kHz	I_{out}	[A]	86.0	104.0
4 kHz	I_{out}	[A]	86.0	104.0
8 kHz	I_{out}	[A]	73.0	78.0
16 kHz	I_{out}	[A]	38.3	41.0

Rated data for 60 s overload

Max. output current ²⁾	I_{max, out}	[A]	129.0	156.0
Reduced output current ²⁾	I_{red, out}	[A]	64.5	78.0
Overload time ²⁾	t_{ol}	[s]	60.0	
Recovery time ²⁾	t_{re}	[s]	120.0	

Rated data for 0.5 s overload

Max. short-time output current ²⁾	I_{max, out}	[A]	172.0	208.0
Reduced output current ²⁾	I_{red, out}	[A]	64.5	78.0
Overload time ²⁾	t_{ol}	[s]	0.5	
Recovery time ²⁾	t_{re}	[s]	4.5	

1) → 10 - See product key

2) → 24 - See diagram



Rated data for Single Drives

► The data is valid for operation at 3/PE 400 V AC or 565 V DC. Unless otherwise specified, the data refers to the default setting.

→ Rated data for operation at 3/PE/AC 500 V
DS_9400_0001
 Available for download at www.lenze.de/dsc

				
Typical motor power 4-pole asynchronous motor	P	[kW]	45.0	55.0
Product key ¹⁾ Single Drive			E94AS□E0864	E94AS□E1044
Rated DC-bus current	I_{N, DC}	[A]	96.8	116.4
Power loss	P_V	[W]	1500	1800
Dimensions				
Height	h	[mm]		655
Height, including fastening	h	[mm]		706
Width	b	[mm]		266
Depth	t	[mm]		370
Mass	m	[kg]		42.0
Max. cable length shielded C2 without external measures	I_{max}	[m]		50
shielded C2 with external measures	I_{max}	[m]		100

Brake chopper rated data

Rated power, Brake chopper ²⁾	P_N	[kW]	37.9	46.3
Max. output power, Brake chopper ²⁾	P_{max, 1}	[kW]	70.1	
Running time ²⁾	t_{on}	[s]	320.0	400.0
Recovery time ²⁾	t_{re}	[s]	280.0	200.0
Min. brake resistance ²⁾	R_{min}	[Ω]	7.5	

¹⁾ →  10 - See product key

²⁾ →  24 - See diagram





Servo Drives 9400

Single Drive

Rated data for Single Drives

► The data is valid for operation at 3/PE 400 V AC or 565 V DC. Unless otherwise specified, the data refers to the default setting.

► Rated data for operation at 3/PE/AC 500 V
DS_9400_0001
 Available for download at www.lenze.de/dsc

											
Typical motor power 4-pole asynchronous motor	P	[kW]	75.0	85.0 ³⁾	95.0 ⁴⁾	90.0	105 ³⁾	110 ⁴⁾	105	125 ³⁾	135 ⁴⁾
Product key ¹⁾ Single Drive			E94AS□E1454			E94AS□E1724			E94AS□E2024		
Mains voltage range	U _{AC}	[V]	3/PE AC 342 V-0 % ... 550 V+0 %, 48 Hz-0 % ... 65 Hz+0 %								
Rated mains current With mains choke	I _{N, AC}	[A]	140.0			166.0			195.0		
Without mains choke	I _{N, AC}	[A]	140.0			166.0			195.0		
Rated output current	I _{N, out}	[A]	145.0			172.0			202.0		
Rated switching frequency	f _{ch}	[kHz]	4								
Output current 2 kHz	I _{out}	[A]	145.0	160.0	177.0	172.0	195.0	212.0	202.0	240.0	260.0
4 kHz	I _{out}	[A]	145.0			172.0			202.0		
8 kHz	I _{out}	[A]	102.0			120.0			131.0		
16 kHz	I _{out}	[A]									

Rated data for 60 s overload

Max. output current ²⁾	I _{max, out}	[A]	218.0	195.0	258.0	233.0	303.0	286.0			
Reduced output current ²⁾	I _{red, out}	[A]	109.0	145.0	168.0	129.0	180.0	201.0	152.0	226.0	247.0
Overload time ²⁾	t _{ol}	[s]	60.0								
Recovery time ²⁾	t _{re}	[s]	120.0								

Rated data for 10 s overload

Max. short-time output current ²⁾	I _{max, out}	[A]	261.0	218.0	195.0	310.0	258.0	233.0	364.0	303.0	286.0
Reduced output current ²⁾	I _{red, out}	[A]	109.0	145.0	168.0	129.0	180.0	201.0	152.0	226.0	247.0
Overload time ²⁾	t _{ol}	[s]	10.0								
Recovery time ²⁾	t _{re}	[s]	50.0								

1) →  10 - See product key

2) →  24 - See diagram

3) This column applies to an ambient temperature of 40 °C and a fixed switching frequency of 2 kHz.

4) The column is valid at an ambient temperature of 40 degrees Celsius, with a fixed switching frequency of 2 kHz and a max. mains voltage of AC 440 V.





Rated data for Single Drives

► The data is valid for operation at 3/PE 400 V AC or 565 V DC. Unless otherwise specified, the data refers to the default setting.

→ Rated data for operation at 3/PE/AC 500 V
DS_9400_0001

Available for download at www.lenze.de/dsc

											
Typical motor power 4-pole asynchronous motor	P	[kW]	75.0	85.0	95.0	90.0	105	110	105	125	135
Product key ¹⁾ Single Drive			E94AS□E1454			E94AS□E1724			E94AS□E2024		
Rated DC-bus current	I_{N, DC}	[A]	171.0			203.0			239.0		
Power loss	P_V	[W]	2100			2200			2600		
Dimensions											
Height	h	[mm]	897						1166		
Height, including fastening	h	[mm]	930						1199		
Width	b	[mm]				407					
Depth	t	[mm]				427					
Mass	m	[kg]	95.0			107.0			109.0		
Max. cable length shielded C2 without external measures	I_{max}	[m]				150					
shielded C2 with external measures	I_{max}	[m]				150					

Brake chopper rated data

Rated power, Brake chopper ²⁾	P_N	[kW]	31.5			36.7			45.1		
Max. output power, Brake chopper ²⁾	P_{max, 1}	[kW]	105.1			122.2			150.2		
Running time ²⁾	t_{on}	[s]				60.0					
Recovery time ²⁾	t_{re}	[s]				540.0					
Min. brake resistance ²⁾	R_{min}	[Ω]	5.0			4.3			3.5		

¹⁾ →  10 - See product key

²⁾ →  24 - See diagram



Servo Drives 9400

Single Drive

Rated data for Single Drives

► The data is valid for operation at 3/PE 400 V AC or 565 V DC. Unless otherwise specified, the data refers to the default setting.

→ Rated data for operation at 3/PE/AC 500 V
DS_9400_0001

Available for download at www.lenze.de/dsc



											
Typical motor power 4-pole asynchronous motor	P	[kW]	130	160³⁾	165⁴⁾	150	190³⁾	210⁴⁾	190	235³⁾	250⁴⁾
Product key¹⁾ Single Drive			E94AS□E2454			E94AS□E2924			E94AS□E3664		
Mains voltage range	U_{AC}	[V]	3/PE AC 342 V-0 % ... 550 V+0 %, 48 Hz-0 % ... 65 Hz+0 %								
Rated mains current With mains choke	I_{N, AC}	[A]	237.0			280.0			354.0		
Without mains choke	I_{N, AC}	[A]	237.0			280.0			354.0		
Rated output current	I_{N, out}	[A]	315.0			395.0			443.0		
Rated switching frequency	f_{ch}	[kHz]	2								
Output current 2 kHz	I_{out}	[A]	245.0	302.0	315.0	292.0	361.0	395.0	366.0	443.0	480.0
4 kHz	I_{out}	[A]	209.0			250.0			313.0		
8 kHz	I_{out}	[A]	160.0			191.0			240.0		
16 kHz	I_{out}	[A]									

Rated data for 60 s overload

Max. output current²⁾	I_{max, out}	[A]	368.0	347.0	438.0	435.0	549.0	528.0			
Reduced output current²⁾	I_{red, out}	[A]	184.0	275.0	299.0	219.0	330.0	375.0	275.0	415.0	456.0
Overload time²⁾	t_{ol}	[s]	60.0								
Recovery time²⁾	t_{re}	[s]	120.0								

Rated data for 10 s overload

Max. short-time output current²⁾	I_{max, out}	[A]	441.0	368.0	347.0	526.0	438.0	435.0	659.0	549.0	528.0
Reduced output current²⁾	I_{red, out}	[A]	184.0	275.0	299.0	219.0	330.0	375.0	275.0	415.0	456.0
Overload time²⁾	t_{ol}	[s]	10.0								
Recovery time²⁾	t_{re}	[s]	50.0								

¹⁾ →  10 - See product key

²⁾ →  24 - See diagram

³⁾ This column applies to an ambient temperature of 40 °C and a fixed switching frequency of 2 kHz.

⁴⁾ The column is valid at an ambient temperature of 40 degrees Celsius, with a fixed switching frequency of 2 kHz and a max. mains voltage of AC 440 V.



Rated data for Single Drives

▶ The data is valid for operation at 3/PE 400 V AC or 565 V DC. Unless otherwise specified, the data refers to the default setting.

→ Rated data for operation at 3/PE/AC 500 V
DS_9400_0001
 Available for download at www.lenze.de/dsc

											
Typical motor power 4-pole asynchronous motor	P	[kW]	130	160	165	150	190	210	190	235	250
Product key ¹⁾ Single Drive			E94AS□E2454			E94AS□E2924			E94AS□E3664		
Rated DC-bus current	I_{N, DC}	[A]	290.0			343.0			434.0		
Power loss	P_V	[W]	3300			4100			4900		
Dimensions											
Height	h	[mm]				1546					
Height, including fastening	h	[mm]				1580					
Width	b	[mm]				407					
Depth	t	[mm]				427					
Mass	m	[kg]				132.0			161.0		
Max. cable length shielded C2 without external measures	I_{max}	[m]				150					
shielded C2 with external measures	I_{max}	[m]				150					

Brake chopper rated data

Rated power, Brake chopper ²⁾	P_N	[kW]	56.3			68.6			90.1		
Max. output power, Brake chopper ²⁾	P_{max, 1}	[kW]	187.7			228.5			300.4		
Running time ²⁾	t_{on}	[s]				60.0					
Recovery time ²⁾	t_{re}	[s]				540.0					
Min. brake resistance ²⁾	R_{min}	[Ω]	2.8			2.3			1.8		

¹⁾ →  10 - See product key

²⁾ →  24 - See diagram



Servo Drives 9400

Single Drive

Rated data for Single Drives

► The data is valid for operation at 3/PE 400 V AC or 565 V DC. Unless otherwise specified, the data refers to the default setting.

→ Rated data for operation at 3/PE/AC 500 V
DS_9400_0001
 Available for download at www.lenze.de/dsc

								
Typical motor power 4-pole asynchronous motor	P	[kW]	240	290³⁾	315⁴⁾	300	320³⁾	345⁴⁾
Product key¹⁾ Single Drive			E94AS□E4604			E94AS□E5724		
Mains voltage range	U_{AC}	[V]	3/PE AC 342 V-0 % ... 550 V+0 %, 48 Hz-0 % ... 65 Hz+0 %					
Rated mains current With mains choke	I_{N, AC}	[A]	444.0			553.0		
Without mains choke	I_{N, AC}	[A]	444.0			553.0		
Rated output current	I_{N, out}	[A]	460.0		572.0			
Rated switching frequency	f_{ch}	[kHz]	2					
Output current 2 kHz	I_{out}	[A]	460.0	550.0	600.0	572.0	610.0	658.0
4 kHz	I_{out}	[A]	386.0		458.0			
8 kHz	I_{out}	[A]	260.0		286.0			
16 kHz	I_{out}	[A]						

Rated data for 60 s overload

Max. output current²⁾	I_{max, out}	[A]	690.0		660.0		858.0		724.0
Reduced output current²⁾	I_{red, out}	[A]	345.0	522.0	570.0	429.0	550.0	625.0	
Overload time²⁾	t_{ol}	[s]	60.0						
Recovery time²⁾	t_{re}	[s]	120.0						

Rated data for 10 s overload

Max. short-time output current²⁾	I_{max, out}	[A]	828.0	690.0	660.0	1030.0	858.0	724.0
Reduced output current²⁾	I_{red, out}	[A]	345.0	522.0	570.0	429.0	550.0	625.0
Overload time²⁾	t_{ol}	[s]	10.0					
Recovery time²⁾	t_{re}	[s]	50.0					

1) →  10 - See product key

2) →  24 - See diagram

3) This column applies to an ambient temperature of 40 °C and a fixed switching frequency of 2 kHz.

4) The column is valid at an ambient temperature of 40 degrees Celsius, with a fixed switching frequency of 2 kHz and a max. mains voltage of AC 440 V.



Rated data for Single Drives

► The data is valid for operation at 3/PE 400 V AC or 565 V DC. Unless otherwise specified, the data refers to the default setting.

→ Rated data for operation at 3/PE/AC 500 V
DS_9400_0001
 Available for download at www.lenze.de/dsc

								
Typical motor power 4-pole asynchronous motor	P	[kW]	240	290	315	300	320	345
Product key ¹⁾ Single Drive			E94AS□E4604			E94AS□E5724		
Rated DC-bus current	I_{N, DC}	[A]	544.0			677.0		
Power loss	P_V	[W]	6200			7200		
Dimensions								
Height	h	[mm]	1559					
Height, including fastening	h	[mm]	1547					
Width	b	[mm]	568					
Depth	t	[mm]	541					
Mass	m	[kg]	266.0			278.0		
Max. cable length shielded C2 without external measures	I_{max}	[m]	150					
shielded C2 with external measures	I_{max}	[m]	150					

Brake chopper rated data

Rated power, Brake chopper ²⁾	P_N	[kW]	99.0					
Max. output power, Brake chopper ²⁾	P_{max, 1}	[kW]	375.0			438.0		
Running time ²⁾	t_{on}	[s]	30.0			28.0		
Recovery time ²⁾	t_{re}	[s]	270.0			272.0		
Min. brake resistance ²⁾	R_{min}	[Ω]	1.4			1.2		

¹⁾ →  10 - See product key

²⁾ →  24 - See diagram



Servo Drives 9400

Single Drive

Rated data for Single Drives

► The data is valid for operation at 3/PE 400 V AC or 565 V DC. Unless otherwise specified, the data refers to the default setting.

► Rated data for operation at 3/PE/AC 500 V
DS_9400_0001
 Available for download at www.lenze.de/dsc

								
Typical motor power 4-pole asynchronous motor	P	[kW]	335	355³⁾	390⁴⁾	370	385³⁾	420⁴⁾
Product key¹⁾ Single Drive			E94AS□E6354			E94AS□E6954		
Mains voltage range	U_{AC}	[V]	3/PE AC 342 V-0 % ... 550 V+0 %, 48 Hz-0 % ... 65 Hz+0 %					
Rated mains current With mains choke	I_{N, AC}	[A]	614.0			672.0		
Without mains choke	I_{N, AC}	[A]	614.0			672.0		
Rated output current	I_{N, out}	[A]	635.0			800.0		
Rated switching frequency	f_{ch}	[kHz]	2					
Output current 2 kHz	I_{out}	[A]	635.0	678.0	745.0	695.0	730.0	800.0
4 kHz	I_{out}	[A]	508.0			556.0		
8 kHz	I_{out}	[A]	318.0			348.0		
16 kHz	I_{out}	[A]						

Rated data for 60 s overload

Max. output current²⁾	I_{max, out}	[A]	953.0	820.0	1043.0	880.0		
Reduced output current²⁾	I_{red, out}	[A]	476.0	610.0	708.0	521.0	653.0	760.0
Overload time²⁾	t_{ol}	[s]	60.0					
Recovery time²⁾	t_{re}	[s]	120.0					

Rated data for 10 s overload

Max. short-time output current²⁾	I_{max, out}	[A]	1143.0	953.0	820.0	1251.0	1043.0	880.0
Reduced output current²⁾	I_{red, out}	[A]	476.0	610.0	708.0	521.0	653.0	760.0
Overload time²⁾	t_{ol}	[s]	10.0					
Recovery time²⁾	t_{re}	[s]	50.0					

1) →  10 - See product key

2) →  24 - See diagram

3) This column applies to an ambient temperature of 40 °C and a fixed switching frequency of 2 kHz.

4) The column is valid at an ambient temperature of 40 degrees Celsius, with a fixed switching frequency of 2 kHz and a max. mains voltage of AC 440 V.



Rated data for Single Drives

▶ The data is valid for operation at 3/PE 400 V AC or 565 V DC. Unless otherwise specified, the data refers to the default setting.

→ Rated data for operation at 3/PE/AC 500 V
DS_9400_0001
 Available for download at www.lenze.de/dsc

								
Typical motor power 4-pole asynchronous motor	P	[kW]	335	355	390	370	385	420
Product key ¹⁾ Single Drive			E94AS□E6354			E94AS□E6954		
Rated DC-bus current	I_{N, DC}	[A]	752.0			823.0		
Power loss	P_V	[W]	7700			7800		
Dimensions								
Height	h	[mm]	1559					
Height, including fastening	h	[mm]	1547					
Width	b	[mm]	568					
Depth	t	[mm]	541					
Mass	m	[kg]	300.0			321.0		
Max. cable length shielded C2 without external measures	I_{max}	[m]	150					
shielded C2 with external measures	I_{max}	[m]	150					

Brake chopper rated data

Rated power, Brake chopper ²⁾	P_N	[kW]	99.0				
Max. output power, Brake chopper ²⁾	P_{max, 1}	[kW]	478.0				
Running time ²⁾	t_{on}	[s]	25.0				
Recovery time ²⁾	t_{re}	[s]	275.0				
Min. brake resistance ²⁾	R_{min}	[Ω]	1.1				

¹⁾ →  10 - See product key

²⁾ →  24 - See diagram



Servo Drives 9400

Single Drive accessories

Installation backplane

Click – the innovative assembly concept

Up to a rated current of 23.5 A the Servo Drives 9400 consist of an axis module and an installation backplane. The backplane can be mounted first without the axis module in the control cabinet, thus simplifying installation.

This offers additional advantages in terms of reduced spare part stocking and time savings in the event of drive replacements.

Further features of the installation backplane:

- ▶ A brake module for a 24 V DC 2.5 A brake can be installed as an option
- ▶ Shields for power and control cables can be connected

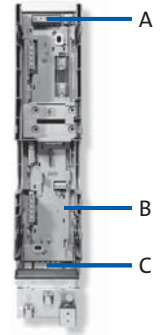

Installation backplane for Single Drive:

A: mains connection
B: brake module (optional)
C: motor connection

Assignment of Single Drive axes and backplanes

Typical motor power 4-pole asynchronous motor	Mains voltage	Product key		Mode
		Single Drive	Installation backplane	Installation backplane
P	U _{AC}			
[kW]	[V]			
0.37	3 AC 180 ... 550	E94AS□E0024	E94AZPS0034N	Without brake module
			E94AZPS0034H□0051	With brake module
E94AS□E0034		E94AZPS0034N	Without brake module	
		E94AZPS0034H□0051	With brake module	
1.50		E94AS□E0044	E94AZPS0074N	Without brake module
			E94AZPS0074H□0051	With brake module
3.00		E94AS□E0074	E94AZPS0074N	Without brake module
			E94AZPS0074H□0051	With brake module
5.50		E94AS□E0134	E94AZPS0244N	Without brake module
			E94AZPS0244H□0051	With brake module
7.50		E94AS□E0174	E94AZPS0244N	Without brake module
			E94AZPS0244H□0051	With brake module
11.0		E94AS□E0244	E94AZPS0244N	Without brake module
			E94AZPS0244H□0051	With brake module



DC busbar set for Single Drive installation backplane

Running the Single Drive axis module in a DC-bus connection (multi-axis application) requires retrofitting the DC busbar system and using DC fuses.

Mechanical coupling is possible with the following components:

- ▶ Power supply module
- ▶ DC input module
- ▶ Single Drive axis modules
- ▶ Multi Drive axis modules

For retrofitting the DC busbar system and the DC fuse have to be installed in the axis module's installation backplane, which is provided with the appropriate fixtures.

The DC fuse required is part of the DC busbar set. Spare fuses are not contained in the scope of supply.

Product key		
Installation backplane	DC busbar mounting set	Replacement DC fuses
E94AZPS0034N	E94AZJA003	EFSAR0016ARHN
E94AZPS0034H□0051		
E94AZPS0074N	E94AZJA007	EFSAR0040ARHN
E94AZPS0074H□0051		
E94AZPS0244N	E94AZJA024	EFSAR0100ARZN
E94AZPS0244H□0051		



Servo Drives 9400

Single Drive accessories

Brake modules

Internal activation

An intelligent motor brake logic system is included as standard in the axis modules' device software in the form of a function block.





The brake modules are available in numerous designs.

The optionally integrable brake modules enable a DC 24 V, DC 180 V or DC 205 V brake to be easily connected and this logic to be used.

- ▶ For axis modules up to 23.5 A, the brake module is integrated into the installation backplane.
- ▶ For axis modules above 32 A, the brake module is integrated into the axis modules.





Brake module, can be integrated into installation backplane

Mode		Features	Product key
Brake module			
24 V DC/0.3 - 2.5 A		<ul style="list-style-type: none"> ▶ 24 V DC external supply voltage ▶ Monitoring of power supply and brake cable for open circuit and short circuit ▶ Polarity reversal protection for supply voltage ▶ Can be integrated into the installation backplanes, up to 32 A 	E94AZHX0051
24 V DC/1.0 - 5.0 A		<ul style="list-style-type: none"> ▶ 24 V DC external supply voltage ▶ Monitoring of power supply and brake cable for open circuit and short circuit ▶ Polarity reversal protection for supply voltage ▶ Can be integrated into the axis modules, from 32 A 	E94AZHY0101
180 V DC/0.1 - 0.61 A		<ul style="list-style-type: none"> ▶ 400 V AC external supply voltage ▶ Monitoring of power supply and brake cable for open circuit and short circuit ▶ Polarity reversal protection for supply voltage ▶ Can be integrated into the axis modules, from 32 A 	E94AZHY0026
205 V DC/0.1 - 0.75 A		<ul style="list-style-type: none"> ▶ External supply voltage 230 V AC ▶ Monitoring of power supply and brake cable for open circuit and short circuit ▶ Polarity reversal protection for supply voltage ▶ Can be integrated into the axis modules, from 32 A 	E94AZHY0025

External activation



Due to their functional principle, the motor brake in Single Drives cannot be released if there is no mains or DC-bus voltage. Brake modules which can be activated externally are therefore provided for a 24V brake.

Mode		Features	Product key
Brake module			
24 V DC/0.3 - 2.5 A		<ul style="list-style-type: none"> ▶ 24 V DC external supply voltage ▶ Monitoring of power supply and brake cable for open circuit and short circuit ▶ Polarity reversal protection for supply voltage ▶ Can be integrated into the installation backplanes, up to 32 A 	E94AZHA0051
24 V DC/1.0 - 5.0 A		<ul style="list-style-type: none"> ▶ 24 V DC external supply voltage ▶ Monitoring of power supply and brake cable for open circuit and short circuit ▶ Polarity reversal protection for supply voltage ▶ Can be integrated into the axis modules, from 32 A 	E94AZHB0101



External brake modules

The external brake modules are provided for DIN rail installation and can be used if axis modules up to 23.5A require brake voltages of 180V DC and 205V DC.

Mode		Features	Product key
Brake module			
180 V DC/0.1 - 0.75 A		<ul style="list-style-type: none"> ▶ 400 V AC external supply voltage ▶ Monitoring of power supply and brake cable for open circuit and short circuit ▶ Polarity reversal protection for supply voltage ▶ Preconfigured for DIN rail mounting 	E94AZHN0026
205 V DC/0.1 - 0.75 A		<ul style="list-style-type: none"> ▶ External supply voltage 230 V AC ▶ Monitoring of power supply and brake cable for open circuit and short circuit ▶ Polarity reversal protection for supply voltage ▶ Preconfigured for DIN rail mounting 	E94AZHN0025



Servo Drives 9400

Single Drive accessories

Brake resistors

The assignment of brake resistors to the Single Drive axis modules is shown in the table below.



Brake resistor 82 ohms

Typical motor power	Mains voltage	Product key		Rated resistance	Rated power	Thermal capacity	Dimensions	Mass
		Single Drive	Brake resistor					
P	U _{AC}			R _N	P _N	C _{th}	h x b x t	m
[kW]	[V]			[Ω]	[W]	[KW _s]	[mm]	[kg]
0.37	3 AC 180 ... 550 ¹⁾	E94AS□E0024	ERBP082R200W	82.0	200.0	30	320 x 41 x 122	1.0
0.75		E94AS□E0034						
1.50		E94AS□E0044	ERBP047R200W	47.0	400.0	60	400 x 110 x 105	2.3
			ERBS047R400W					
			ERBS047R800W					
3.00		E94AS□E0074	ERBP047R200W	47.0	200.0	30	320 x 41 x 122	1.0
			ERBS047R400W					
			ERBS047R800W					
5.50		E94AS□E0134	ERBP027R200W	27.0	200.0	30	320 x 41 x 122	1.0
			ERBS027R600W					
			ERBS027R01K2					
7.50		E94AS□E0174	ERBP018R300W	18.0	300.0	30	240 x 41 x 122	1.4
			ERBS018R800W					
			ERBS018R02K8					
11.0		E94AS□E0244	ERBP018R300W	18.0	300.0	30	240 x 41 x 122	1.4
			ERBS018R01K2					
			ERBS018R02K8					
15.0		E94AS□E0324	ERBS018R800W	15.0	800.0	120	710 x 110 x 105	3.9
			ERBS018R01K4					
			ERBG018R04K3					
22.0	E94AS□E0474	ERBS015R800W	15.0	800.0	120	710 x 110 x 105	3.9	
		ERBS015R02K4						
		ERBG015R06K2						
30.0	E94AS□E0594	ERBS015R01K2	15.0	1200.0	180	1020 x 110 x 105	5.6	
		ERBG015R03K3						
		ERBG015R10K0						
				10000.0	1440	380 x 736 x 302	22.0	

¹⁾ For 230 V mains voltage a different brake resistor assignment applies.

→ Data sheet on brake resistors
DS_9400_0002
 Available for download at www.lenze.de/dsc



Brake resistors

The assignment of brake resistors to Single Drive axis modules is shown in the table below.

- ▶ Two resistors should be connected in parallel for the following combinations:
 E94AS□E3664 and ERBG035D03K3
 E94AS□E4604 and ERBG028D04K1
 E94AS□E5724 and ERBG023D05K6
 E94AS□E6354 and ERBG023D05K6
 E94AS□E6954 and ERBG023D05K6



3.5 ohm brake resistor

Typical motor power	Mains voltage	Product key		Rated resistance	Rated power	Thermal capacity	Dimensions	Mass
		Single Drive	Brake resistor					
4-pole asynchronous motor								
P	U _{AC}			R _N	P _N	C _{th}	h x b x t	m
[kW]	[V]			[Ω]	[W]	[KW _s]	[mm]	[kg]
45.0	3 AC 180 ... 550 ¹⁾	E94AS□E0864	ERBG075D01K9	7.5	1900.0	285	486 x 236 x 302	9.5
55.0		E94AS□E1044						
75.0	3 AC 342 ... 550	E94AS□E1454	ERBG005R02K6	5.0	2600.0	390	486 x 326 x 302	12.6
90.0		E94AS□E1724	ERBG043D03K0	4.3	3000.0	450		11.8
105		E94AS□E2024	ERBG035D03K3	3.5	3300.0	495		12.6
130		E94AS□E2454	ERBG028D04K1	2.8	4100.0	615	486 x 426 x 302	12.8
150		E94AS□E2924	ERBG023D05K6	2.3	5600.0	840		15.9
190		E94AS□E3664	ERBG035D03K3	3.5	3300.0	495	486 x 326 x 302	12.6
240		E94AS□E4604	ERBG028D04K1	2.8	4100.0	615	486 x 426 x 302	12.8
300		E94AS□E5724	ERBG023D05K6	2.3	5600.0	840		486 x 426 x 302
335		E94AS□E6354						
370		E94AS□E6954						

¹⁾ For 230 V mains voltage a different brake resistor assignment applies.

→ Data sheet on brake resistors
DS_9400_0002
 Available for download at www.lenze.de/dsc



Servo Drives 9400

Single Drive accessories

Mains chokes

A mains choke is an inductor that is connected to the mains cable of the inverter. Using a mains choke offers the following advantages:

- ▶ **Less system perturbation:**
The wave form of the mains current is a closer approximation of a sine wave.
- ▶ **Reduced r.m.s. mains current:**
Reduction in mains, cable and fuse load

A mains choke can be used without restriction together with RFI filters and/or sinusoidal filters.

Please note:

Using a mains choke slightly reduces the mains voltage at the inverter input - the typical voltage drop on the mains choke at the rated point is approximately 5%.

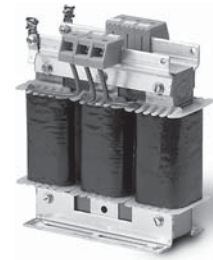

Mains choke

Typical motor power	Mains voltage	Product key		Rated current	Dimensions	Mass
		Single Drive	Mains choke			
4-pole asynchronous motor						
P	U _{AC}			I _N	h x b x t	m
[kW]	[V]			[A]	[mm]	[kg]
0.37	3 AC 180 ... 550	E94AS□E0024	ELN3-1500H003-001	2.5	105 x 129 x 61	1.2
0.75		E94AS□E0034				
1.50		E94AS□E0044	ELN3-0900H004-001	4.0	105 x 129 x 70	1.5
3.00		E94AS□E0074	ELN3-0500H007-001	7.0	122 x 148 x 63	2.6
5.50		E94AS□E0134	ELN3-0250H013-001	13.0	142 x 178 x 90	5.3
7.50		E94AS□E0174	ELN3-0170H017-001	17.0	140 x 178 x 75	3.9
11.0		E94AS□E0244	ELN3-0150H024-001	24.0	170 x 219 x 111	8.2

- ▶ The mains choke is integrated in the Single Drives as of a 32 A rated current.





Servo Drives 9400

Single Drive accessories

RFI and mains filters

RFI filters and mains filters enable compliance with the interference voltage categories of the European standard EN 61800-3. There a distinction is drawn between category C1 and category C2.

Category C1 describes the use on public supply networks.

Category C2 describes the use of drives which are intended to be used for industrial purposes in areas also comprising residential areas.



RFI filter, can be mounted beside or below the axis module

RFI filter

RFI filters are capacitive accessory components which can be connected directly upstream of the axis modules. This measure enables compliance with the corresponding conducted noise emission requirements according to EN61800-3.

Typical motor power	Mains voltage	Product key		Rated current	Power loss	Max. cable length		Dimensions	Mass
		Single Drive	RFI filter			shielded C1 with external measures	shielded C2 with external measures		
P	U _{AC}			I _N	P _V	I _{max}	I _{max}	h x b x t	m
[kW]	[V]			[A]	[W]	[m]	[m]	[mm]	[kg]
0.37	3 AC 180 ... 550	E94AS□E0024	E94AZRS0044	3.5	4	0	50	522 x 60 x 60	1.8
0.75		E94AS□E0034							
1.50		E94AS□E0044	E94AZRS0104	10.0	8			522 x 90 x 60	2.3
3.00		E94AS□E0074							
5.50		E94AS□E0134	E94AZRS0294	29.0	22			522 x 120 x 60	3.6
7.50		E94AS□E0174							
11.0		E94AS□E0244							
15.0		E94AS□E0324	E94AZRS0544	54.0	50	670 x 201 x 60	9.0		
22.0		E94AS□E0474							
30.0		E94AS□E0594							
45.0		E94AS□E0864	E94AZRS0954	95.0	70	780 x 261 x 60	13.0		
55.0		E94AS□E1044							

→ Data sheet on RFI filters
DS_9400_0003
 Available for download at www.lenze.com/dsc



Mains filter

A mains filter is a combination of mains choke and RFI filter in one housing. It reduces line-bound noise emission into the mains, thus ensuring that the line-bound interference voltage is reduced to a permissible level according to EN61800-3.



Mains filter, can be mounted beside or below the axis module

Typical motor power	Mains voltage	Product key		Rated current	Voltage drop	Max. cable length		Dimensions	Mass
		Single Drive	Mains filter			shielded C1 with external measures	shielded C2 with external measures		
P	U _{AC}			I _N	U	I _{max}	I _{max}	h x b x t	m
[kW]	[V]			[A]	[V]	[m]	[m]	[mm]	[kg]
0.37	3 AC 180 ... 550	E94AS□E0024	E94AZMS0034	3.2	10.0	25	50	522 x 60 x 60	3.3
0.75		E94AS□E0034							
1.50		E94AS□E0044	E94AZMS0094	9.0	7.4	100	522 x 90 x 60	3.9	
3.00		E94AS□E0074							
5.50		E94AS□E0134	E94AZMS0184	18.0	7.3	522 x 120 x 60	8.4		
7.50		E94AS□E0174							
11.0		E94AS□E0244	E94AZMS0314	31.0			8.8		

→ Data sheet on mains filters
DS_9400_0004
 Available for download at www.lenze.de/dsc



Servo Drives 9400

Single Drive accessories

Sinusoidal filter

A sinusoidal filter in the motor cable limits the rate of rise of voltage and the capacitive charge/discharge currents which occur during inverter operation. When used in combination with the specified line filter, the EMC limit class for conducted interference C2 is complied with, even if – depending on the drive – relatively long shielded or even unshielded motor cables are used.

Application range:

- ▶ Only use sinusoidal filters with 0 to 500 V standard asynchronous motors
- ▶ Operation only with U/f or U/f² control
- ▶ Set the switching frequency to the stated value
- ▶ Limit the output frequency of the Servo Drives 9400 to the stated value



Sinusoidal filter

Typical motor power	Mains voltage	Product key				Max. output frequency	Rated inductance	Switching frequency	Mass
		Single Drive	RFI filter	Mains filter	Sinusoidal filter				
4-pole asynchronous motor									
P	U _{AC}					f _{max}	L _N	f _{ch}	m
[kW]	[V]					[Hz]	[mH]	[kHz]	[kg]
0.37	3 AC 180 ... 550	E94AS□E0024		E94AZMS0034	EZS3-004A200	150	11.0		4.0
0.75		E94AS□E0034		E94AZMS0094	EZS3-010A200		5.10		
1.50		E94AS□E0044		E94AZMS0184	EZS3-024A200		2.50		
3.00		E94AS□E0074		E94AZMS0314	EZS3-037A200		1.70		
5.50		E94AS□E0134	E94AZRS0544	EZS3-048A200	1.20		8	26.5	
7.50		E94AS□E0174		EZS3-061A200	1.00				
11.0		E94AS□E0244		EZS3-072A200	0.95				
15.0		E94AS□E0324		EZS3-115A200	0.70				
22.0		E94AS□E0474	E94AZRS0954	EZS3-150A200	0.50		2	42.0	
30.0		E94AS□E0594					4		
45.0		E94AS□E0864							
55.0		E94AS□E1044							

→ Data sheet on sinusoidal filters
DS_ZB_EZS3_0001
 Available for download at www.lenze.de/dsc



Sinusoidal filter

Typical motor power	Mains voltage	Product key		Max. output frequency	Rated inductance	Switching frequency	Mass
		Single Drive	Sinusoidal filter				
P	U _{AC}			f _{max}	L _N	f _{ch}	m
[kW]	[V]			[Hz]	[mH]	[kHz]	[kg]
75.0	3 AC 342 ... 550	E94AS□E1454	EZS3-180A200 ³⁾	90.0	0.40	2 4	95.0
90.0		E94AS□E1724	EZS3-250A200 ³⁾		0.35		107.0
105		E94AS□E2024					109.0
130		E94AS□E2454			0.21		132.0
150		E94AS□E2924	EZS3-350A200 ³⁾		0.14		161.0
190		E94AS□E3664	EZS3-480A200 ³⁾		0.21		266.0
240		E94AS□E4604 ¹⁾	EZS3-350A200 ³⁾		0.14		278.0
300		E94AS□E5724 ¹⁾	EZS3-480A200 ³⁾		0.21		300.0
335		E94AS□E6354 ¹⁾					321.0
370		E94AS□E6954 ²⁾	EZS3-350A200 ³⁾				

¹⁾ Two sinusoidal filters must be connected in parallel

²⁾ Three sinusoidal filters must be connected in parallel

³⁾ If the parameters for devices over 75 kW/145 A are set for operation with "increased rated output current" (code C01199), different assignments may be necessary.

→ Data sheet on sinusoidal filters

DS_ZB_EZS3_0001

Available for download at www.lenze.de/dsc



Servo Drives 9400

Multi Drive

Rated data for Multi Drives

- ▶ The data is valid for operation at DC 565 V.
- ▶ Unless otherwise specified, the data refers to the default setting.

					
Typical motor power 4-pole asynchronous motor	P	[kW]	0.37	0.75	1.50
Product key ⁻¹⁾ Multi Drive			E94AM□E0024	E94AM□E0034	E94AM□E0044
DC supply	U_{DC}	[V]	DC 260 V -0 % ... 775 V +0 %		
Rated output current	I_{N, out}	[A]	1.5	2.5	4.0
Rated switching frequency	f_{ch}	[kHz]	8		
Output current 2 kHz	I_{out}	[A]	1.9	3.1	5.0
4 kHz	I_{out}	[A]	1.9	3.1	5.0
8 kHz	I_{out}	[A]	1.5	2.5	4.0
16 kHz	I_{out}	[A]	1.1	1.9	3.0

Rated data for 60 s overload

Max. output current ²⁾	I_{max, out}	[A]	2.8	4.7	7.5
Reduced output current ²⁾	I_{red, out}	[A]	1.4	2.3	3.8
Overload time ²⁾	t_{ol}	[s]	60.0		
Recovery time ²⁾	t_{re}	[s]	120.0		

Rated data for 0.5 s overload

Max. short-time output current ²⁾	I_{max, out}	[A]	6.0	10.0	16.0
Reduced output current ²⁾	I_{red, out}	[A]	1.4	2.3	3.8
Overload time ²⁾	t_{ol}	[s]	0.5		
Recovery time ²⁾	t_{re}	[s]	4.5		

¹⁾ →  10 - See product key

²⁾ →  24 - See diagram



Rated data for Multi Drives

- ▶ The data is valid for operation at DC 565 V.
- ▶ Unless otherwise specified, the data refers to the default setting.

					
Typical motor power 4-pole asynchronous motor	P	[kW]	0.37	0.75	1.50
Product key ¹⁾ Multi Drive			E94AM□E0024	E94AM□E0034	E94AM□E0044
Rated DC-bus current	$I_{N, DC}$	[A]	2.6	4.3	6.7
Power loss	P_V	[W]	100	120	150
Dimensions					
Height	h	[mm]		350	
Height, including fastening	h	[mm]		481	
Width	b	[mm]		60	
Depth	t	[mm]		288	
Mass	m	[kg]		4.0	
Max. cable length					
shielded C1 with external measures	I_{max}	[m]		25	
shielded C2 without external measures	I_{max}	[m]		10	
shielded C2 with external measures	I_{max}	[m]	50		100

¹⁾ →  10 - See product key





Servo Drives 9400

Multi Drive

Rated data for Multi Drives

- ▶ The data is valid for operation at DC 565 V.
- ▶ Unless otherwise specified, the data refers to the default setting.

					
Typical motor power 4-pole asynchronous motor	P	[kW]	3.00	4.00	5.50
Product key ⁻¹⁾ Multi Drive			E94AM□E0074	E94AM□E0094	E94AM□E0134
DC supply	U _{DC}	[V]	DC 260 V -0 % ... 775 V +0 %		
Rated output current	I _{N, out}	[A]	7.0	9.3	13.0
Rated switching frequency	f _{ch}	[kHz]	8		
Output current					
2 kHz	I _{out}	[A]	8.8	11.7	16.3
4 kHz	I _{out}	[A]	8.8	11.7	16.3
8 kHz	I _{out}	[A]	7.0	9.3	13.0
16 kHz	I _{out}	[A]	5.3	7.0	9.8

Rated data for 60 s overload

Max. output current ²⁾	I _{max, out}	[A]	13.1	17.5	24.4
Reduced output current ²⁾	I _{red, out}	[A]	6.6	8.8	12.2
Overload time ²⁾	t _{ol}	[s]	60.0		
Recovery time ²⁾	t _{re}	[s]	120.0		

Rated data for 0.5 s overload

Max. short-time output current ²⁾	I _{max, out}	[A]	21.0	28.0	39.0
Reduced output current ²⁾	I _{red, out}	[A]	6.6	8.8	12.2
Overload time ²⁾	t _{ol}	[s]	0.5		
Recovery time ²⁾	t _{re}	[s]	4.5		



¹⁾ →  10 - See product key

²⁾ →  24 - See diagram



Rated data for Multi Drives

- ▶ The data is valid for operation at DC 565 V.
- ▶ Unless otherwise specified, the data refers to the default setting.

					
Typical motor power 4-pole asynchronous motor	P	[kW]	3.00	4.00	5.50
Product key ⁻¹⁾ Multi Drive			E94AM□E0074	E94AM□E0094	E94AM□E0134
Rated DC-bus current	$I_{N,DC}$	[A]	12.1	15.4	20.6
Power loss	P_V	[W]	190	230	280
Dimensions					
Height	h	[mm]		350	
Height, including fastening	h	[mm]		481	
Width	b	[mm]	90		120
Depth	t	[mm]		288	
Mass	m	[kg]	5.3		8.1
Max. cable length					
shielded C1 with external measures	I_{max}	[m]		25	
shielded C2 without external measures	I_{max}	[m]		10	
shielded C2 with external measures	I_{max}	[m]		100	

¹⁾ →  10 - See product key



Servo Drives 9400

Multi Drive

Rated data for Multi Drives

- ▶ The data is valid for operation at DC 565 V.
- ▶ Unless otherwise specified, the data refers to the default setting.

					
Typical motor power 4-pole asynchronous motor	P	[kW]	7.50	11.0	15.0
Product key ⁻¹⁾ Multi Drive			E94AM□E0174	E94AM□E0244	E94AM□E0324
DC supply	U_{DC}	[V]	DC 260 V -0 % ... 775 V +0 %		
Rated output current	I_{N, out}	[A]	16.5	23.5	32.0
Rated switching frequency	f_{ch}	[kHz]	8		
Output current 2 kHz	I_{out}	[A]	20.6	29.4	40.0
4 kHz	I_{out}	[A]	20.6	29.4	40.0
8 kHz	I_{out}	[A]	16.5	23.5	32.0
16 kHz	I_{out}	[A]	12.4	17.6	24.0

Rated data for 60 s overload

Max. output current ²⁾	I_{max, out}	[A]	30.9	44.1	60.0
Reduced output current ²⁾	I_{red, out}	[A]	15.5	22.1	30.0
Overload time ²⁾	t_{ol}	[s]	60.0		
Recovery time ²⁾	t_{re}	[s]	120.0		

Rated data for 0.5 s overload

Max. short-time output current ²⁾	I_{max, out}	[A]	49.5	70.5	76.8
Reduced output current ²⁾	I_{red, out}	[A]	15.5	22.1	30.0
Overload time ²⁾	t_{ol}	[s]	0.5		
Recovery time ²⁾	t_{re}	[s]	4.5		

¹⁾ →  10 - See product key

²⁾ →  24 - See diagram



Rated data for Multi Drives

- ▶ The data is valid for operation at DC 565 V.
- ▶ Unless otherwise specified, the data refers to the default setting.

					
Typical motor power 4-pole asynchronous motor	P	[kW]	7.50	11.0	15.0
Product key ¹⁾ Multi Drive			E94AM□E0174	E94AM□E0244	E94AM□E0324
Rated DC-bus current	I_{N, DC}	[A]	25.7	35.5	48.0
Power loss	P_V	[W]	320	420	490
Dimensions					
Height	h	[mm]		350	
Height, including fastening	h	[mm]		481	
Width	b	[mm]		120	
Depth	t	[mm]		288	
Mass	m	[kg]		8.1	
Max. cable length					
shielded C1 with external measures	I_{max}	[m]		25	
shielded C2 without external measures	I_{max}	[m]		10	
shielded C2 with external measures	I_{max}	[m]		100	

¹⁾ →  10 - See product key







Servo Drives 9400

Multi Drive

Rated data for power supply modules

► The data is valid for operation at 3/PE AC 400 V.

						
Product key ¹⁾ Power supply module			E94APNE0104	E94APNE0364	E94APNE1004	E94APNE2454
Rated power ²⁾ With mains filter	P_N	[kW]	4.9	17.5	48.6	119.0
Without mains filter	P_N	[kW]	3.6	13.0	36.2	88.6
Mains voltage range	U_{AC}	[V]	3/PE AC 180 V-0 % ... 550 V+0 %, 45 Hz-0 % ... 65 Hz+0 %			
Rated mains current	$I_{N, AC}$	[A]	8.0	29.0	82.0	200.0
Rated DC-bus current	$I_{N, DC}$	[A]	10.0	36.0	100.0	245.0

Rated data for 60 s overload

Max. DC-bus current ²⁾	I_{max}	[A]	15.0	54.0	150.0	368.0
Reduced DC-bus current ²⁾	$I_{red, DC}$	[A]	7.5	27.0	75.0	183.5
Overload time ²⁾	t_{ol}	[s]	120.0			
Recovery time ²⁾	t_{re}	[s]	60.0			
Max. output power ³⁾	$P_{max, 1}$	[kW]	7.4	26.3	72.9	179.0

Rated data for 0.5 s overload

Max. short-time DC-bus current ²⁾	I_{max}	[A]	40.0	108.0	200.0	368.0
Reduced DC-bus current ²⁾	$I_{red, DC}$	[A]	7.5	27.0	75.0	183.5
Overload time ²⁾	t_{ol}	[s]	0.5			
Recovery time ²⁾	t_{re}	[s]	4.5			
Max. short-time output power ³⁾	$P_{max, 2}$	[kW]	19.6	52.5	146.0	357.0

¹⁾ →  12 - See product key – illustration features accessories/modules





²⁾ →  24 - See diagram

³⁾ Mains filter required; if no mains filter is installed, the stated values for P_{max} decrease



Rated data for power supply modules

► The data is valid for operation at 3/PE AC 400 V.

						
Product key ¹⁾ Power supply module			E94APNE0104	E94APNE0364	E94APNE1004	E94APNE2454
Rated power With mains filter	P_N	[kW]	4.9	17.5	48.6	119.0
Without mains filter	P_N	[kW]	3.6	13.0	36.2	88.6
Rated DC-bus current	$I_{N,DC}$	[A]	10.0	36.0	100.0	245.0
Power loss	P_V	[W]	55	110	230	550
Dimensions Height	h	[mm]	350		383	
Height, including fastening	h	[mm]	481		510	
Width	b	[mm]	60	120	210	390
Depth	t	[mm]	288			
Mass	m	[kg]	2.6	5.3	13.5	28.5

Brake chopper rated data

Rated power, Brake chopper ²⁾	P_N	[kW]	2.60	8.70	17.0	30.3
Max. output power, Brake chopper ²⁾	$P_{max,1}$	[kW]	19.5	43.8	105.1	187.7
Running time ²⁾	t_{on}	[s]	0.5			
Recovery time ²⁾	t_{re}	[s]	3.8	2.5	3.1	
Min. brake resistance ²⁾	R_{min}	[Ω]	27.0	12.0	5.0	2.8

¹⁾ →  12 - See product key – illustration features accessories/modules

²⁾ →  24 - See diagram



Servo Drives 9400

Power supply modules

Rated data for regenerative power supply modules

▶ The data is valid for operation at 3/PE AC 400 V.

▶ Mains filter required, see "mains filter" accessory page



Product key ¹⁾ Supply- / regenerative module			E94ARNE0134		E94ARNE0244	
			Feed	Feedback	Feed	Feedback
Operating mode						
Rated power With mains filter	P_N	[kW]	15.0	7.5	27.0	13.5
Mains voltage range	U_{AC}	[V]	3/PE AC 180 V-0 % ... 550 V+0 %, 45 Hz-0 % ... 65 Hz+0 %			
Rated mains current	$I_{N, AC}$	[A]	26.0	13.0	47.0	23.5
Rated DC-bus current	$I_{N, DC}$	[A]	32.0	16.0	57.0	29.0

Rated data for 60 s overload

Max. DC-bus current ²⁾	I_{max}	[A]	48.0	24.0	86.0	44.0
Reduced DC-bus current ²⁾	$I_{red, DC}$	[A]	20.0	9.8	35.0	18.0
Overload time ²⁾	t_{ol}	[s]	60.0			
Recovery time ²⁾	t_{re}	[s]	120.0			
Max. output power	$P_{max, 1}$	[kW]	22.4	11.2	40.5	20.2

Rated data for 0.5 s overload

Max. short-time DC-bus current ²⁾	I_{max}	[A]	96.0	48.0	171.0	87.0
Reduced DC-bus current ²⁾	$I_{red, DC}$	[A]	20.0	9.8	35.0	18.0
Overload time ²⁾	t_{ol}	[s]	0.5			
Recovery time ²⁾	t_{re}	[s]	4.5			
Max. short-time output power	$P_{max, 2}$	[kW]	44.9	22.4	81.1	40.5
with brake chopper support	$P_{max, 2}$	[kW]		35.1		59.6

¹⁾ →  12 - See product key – illustration features accessories/modules

²⁾ →  24 - See diagram



Rated data for regenerative power supply modules

▶ The data is valid for operation at 3/PE AC 400 V.

▶ Mains filter required, see "mains filter" accessory page

						
Product key ¹⁾			E94ARNE0134		E94ARNE0244	
Supply- / regenerative module						
Operating mode			Feed	Feedback	Feed	Feedback
Rated power						
With mains filter	P_N	[kW]	15.0	7.5	27.0	13.5
Rated DC-bus current	$I_{N,DC}$	[A]	32.0	16.0	57.0	29.0
Power loss	P_V	[W]	150	110	230	190
Dimensions						
Height	h	[mm]	350			
Height, including fastening	h	[mm]	481			
Width	b	[mm]	120			
Depth	t	[mm]	288			
Mass	m	[kg]	6.0			

Brake chopper rated data

Rated power, Brake chopper ²⁾	P_N	[kW]	4.70	9.30
Max. output power, Brake chopper ²⁾	$P_{max,1}$	[kW]	19.5	29.2
Running time ²⁾	t_{on}	[s]	0.8	1.1
Recovery time ²⁾	t_{re}	[s]	4.2	3.9
Min. brake resistance ²⁾	R_{min}	[Ω]	27.0	18.0

¹⁾ →  12 - See product key – illustration features accessories/modules

²⁾ →  24 - See diagram



Servo Drives 9400

Multi Drive accessories

Installation backplane

Click – the innovative assembly concept

Up to a rated current of 23.5 A the Servo Drives 9400 consist of an axis module and an installation backplane. This structure is also used for power supply modules up to a rated power of 17.5 kW and for regenerative power supply modules for an incoming supply power of up to 27 kW. The backplane can be mounted first without the axis module in the control cabinet, thus simplifying installation. This offers additional advantages in terms of reduced spare part stocking and time savings in the event of drive replacements. Further features of the installation backplane for Multi Drive devices:

- ▶ A brake module for a 24 V DC 2.5 A brake can be installed as an option
- ▶ Shields for power and control cables can be connected

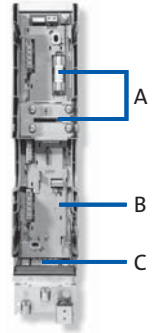

Multi Drive installation backplane:

A: DC fuse and DC busbar
 B: brake module (optional)
 C: motor connection

Assignment of Multi Drive axes and backplanes

Typical motor power 4-pole asynchronous motor	Mains voltage	Product key		Mode
		Multi Drive	Installation backplane	
P [kW]	U _{AC} [V]			
0.37	3 AC 180 ... 550	E94AM□E0024	E94AZPM0044N	Without brake module
			E94AZPM0044H□0051	With brake module
0.75		E94AM□E0034	E94AZPM0044N	Without brake module
			E94AZPM0044H□0051	With brake module
1.50		E94AM□E0044	E94AZPM0044N	Without brake module
			E94AZPM0044H□0051	With brake module
3.00		E94AM□E0074	E94AZPM0094N	Without brake module
			E94AZPM0094H□0051	With brake module
4.00		E94AM□E0094	E94AZPM0094N	Without brake module
			E94AZPM0094H□0051	With brake module
5.50		E94AM□E0134	E94AZPM0244N	Without brake module
			E94AZPM0244H□0051	With brake module
7.50	E94AM□E0174	E94AZPM0244N	Without brake module	
		E94AZPM0244H□0051	With brake module	
11.0	E94AM□E0244	E94AZPM0244N	Without brake module	
		E94AZPM0244H□0051	With brake module	
15.0	E94AM□E0324	E94AZPM0324N	Without brake module	
		E94AZPM0324H□0051	With brake module	



Assignment: power supply modules / regenerative power supply modules and mounting backplane

Rated power With mains filter	Mains voltage	Product key		
		Power supply module	Supply- / regenerative module	Installation backplane
P_N [kW]	U_{AC} [V]			
4.9	3 AC 180 ... 550	E94APNE0104		E94AZPP0104
17.5		E94APNE0364		E94ARNE0134 E94ARNE0244
15.0				
27.0				

Replacement DC fuses for Multi Drive installation backplane

If you need to replace the DC fuse in the Multi Drive installation backplane, the available types are listed in the table below.

Product key	
Installation backplane	Replacement DC fuses
E94AZPM0044N	EFSAR0016ARHN
E94AZPM0044H□0051	
E94AZPM0094N	EFSAR0040ARHN
E94AZPM0094H□0051	
E94AZPM0244N	EFSAR0100ARZN
E94AZPM0244H□0051	
E94AZPM0324N	
E94AZPM0324H□0051	



Servo Drives 9400

Multi Drive accessories

Brake modules

Internal activation

An intelligent motor brake logic system in the form of a function block is included as standard in the axis modules' device software.

The brake modules are available in several designs.

The optionally integrable brake module enables a -24 V DC brake to be easily connected and this logic to be used.

- ▶ For axis modules up to 32 A, the -24 V DC brake module is integrated into the installation backplane.



Brake module, can be integrated into installation backplane

Mode		Features	Product key
Brake module			
24 V DC/0.3 - 2.5 A		<ul style="list-style-type: none"> ▶ 24 V DC external supply voltage ▶ Monitoring of power supply and brake cable for open circuit and short circuit ▶ Polarity reversal protection for supply voltage ▶ Can be integrated into the installation backplanes, up to 32 A 	E94AZHX0051

External activation



Due to their functional principle, the motor brake in Single Drives cannot be released if there is no mains or DC-bus voltage. Brake modules which can be activated externally are therefore provided for a 24V brake.

Mode		Features	Product key
Brake module			
24 V DC/0.3 - 2.5 A		<ul style="list-style-type: none"> ▶ 24 V DC external supply voltage ▶ Monitoring of power supply and brake cable for open circuit and short circuit ▶ Polarity reversal protection for supply voltage ▶ Can be integrated into the installation backplanes, up to 32 A 	E94AZHA0051



External brake modules

The external brake modules are provided for DIN rail installation and can be used if axis modules up to 23.5A require brake voltages of 180V DC and 205V DC.

Mode		Features	Product key
Brake module			
180 V DC/0.1 - 0.75 A		<ul style="list-style-type: none"> ▶ 400 V AC external supply voltage ▶ Monitoring of power supply and brake cable for open circuit and short circuit ▶ Polarity reversal protection for supply voltage ▶ Preconfigured for DIN rail mounting 	E94AZHN0026
205 V DC/0.1 - 0.75 A		<ul style="list-style-type: none"> ▶ External supply voltage 230 V AC ▶ Monitoring of power supply and brake cable for open circuit and short circuit ▶ Polarity reversal protection for supply voltage ▶ Preconfigured for DIN rail mounting 	E94AZHN0025



Servo Drives 9400

Multi Drive accessories

DC input module

Via a DC input module, an axis module interconnection can be supplied with power from a central DC source (power supply module, Single Drive axis modules, Multi Drive axis modules). This is required for example if a drive system with a multi-level structure installed in a control cabinet is to be supplied via a central DC power supply unit. The rated current of the DC input module is defined to be 100 A (DC). The DC input module can be connected at the top or bottom, offering great flexibility with regard to integration into the system wiring. This provides an ideal way of connecting multi-row axis modules in particular.



DC input module
100 A

Mode	Product key	Dimensions	Mass
	Input module		
		h x b x t	m
		[mm]	[kg]
DC input module 100 A	E94AZEX100	422 x 60 x 95	0.9

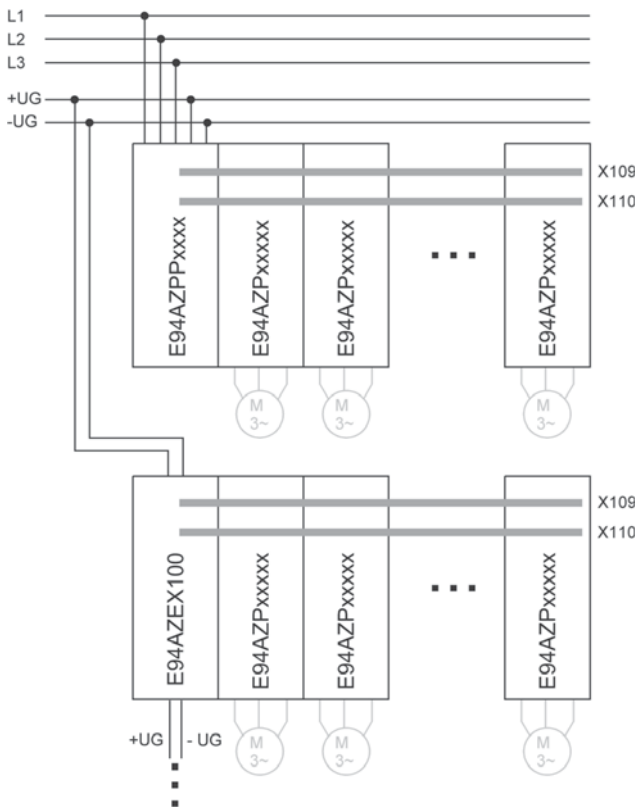

Wiring example for multi-row mounting of axis modules



Brake resistors

Assignment of brake resistors to the supply and regenerative power supply modules is shown in the tables below.



Brake resistor 27 ohms

Brake resistors for power supply modules

Rated power	Mains voltage	Product key		Rated resistance	Rated power	Thermal capacity	Dimensions	Mass
		Power supply module	Brake resistor					
P_N	U_{AC}			R_N	P_N	C_{th}	$h \times b \times t$	m
[kW]	[V]			[Ω]	[W]	[KWs]	[mm]	[kg]
4.9	3 AC 180 ... 550 ¹⁾	E94APNE0104	ERBP027R200W	27.0	200.0	30	320 x 41 x 122	1.0
			ERBS027R600W		600.0	90	550 x 110 x 105	3.1
			ERBS027R01K2		1200.0	180	1020 x 110 x 105	5.6
17.5		E94APNE0364	ERBG012R01K9	12.0	1900.0	285	486 x 236 x 302	13.0
			ERBG012R05K2		5200.0	750	486 x 426 x 302	28.0
48.6		E94APNE1004	ERBG005R02K6	5.0	2600.0	390	486 x 326 x 302	12.6
119.0		E94APNE2454	ERBG028D04K1	2.8	4100.0	615	486 x 426 x 302	12.8

¹⁾ For 230 V mains voltage a different brake resistor assignment applies.

Brake resistors for regenerative power supply modules

Rated power	Mains voltage	Product key		Rated resistance	Rated power	Thermal capacity	Dimensions	Mass
		Supply- / regenerative module	Brake resistor					
P_N	U_{AC}			R_N	P_N	C_{th}	$h \times b \times t$	m
[kW]	[V]			[Ω]	[W]	[KWs]	[mm]	[kg]
15.0	3 AC 180 ... 550 ¹⁾	E94ARNE0134	ERBP027R200W	27.0	200.0	30	320 x 41 x 122	1.0
			ERBS027R600W		600.0	90	550 x 110 x 105	3.1
			ERBS027R01K2		1200.0	180	1020 x 110 x 105	5.6
27.0		E94ARNE0244	ERBP018R300W	18.0	300.0	30	240 x 41 x 122	1.4
			ERBS018R01K2		1200.0	180	1020 x 110 x 105	5.6
			ERBS018R02K8		2800.0	420	1110 x 200 x 105	12.0

²⁾ For 230 V mains voltage a different brake resistor assignment applies.

→ Data sheet on brake resistors
DS_9400_0002
 Available for download at www.lenze.de/dsc



Servo Drives 9400

Multi Drive accessories

RFI and mains filters

RFI filters and mains filters enable compliance with the interference voltage categories of the European standard EN 61800-3. There a distinction is drawn between category C1 and category C2.

Category C1 describes the use on public supply networks.

Category C2 describes the use of drives which are intended to be used for industrial purposes in areas also comprising residential areas.

For Multi Drives external filters must be used to comply with the EMC Directive.



RFI filter, can be mounted beside the power supply module

RFI filter

RFI filters are primarily capacitive accessory components which can be connected directly upstream of the power supply modules. This measure enables compliance with the corresponding conducted noise emission requirements according to EN 61800-3.

Rated power	Mains voltage	Product key		Rated current	Power loss	Max. cable length	Dimensions	Mass
		Power supply module	RFI filter					
P_N	U_{AC}			I_N	P_V	I_{max}	$h \times b \times t$	m
[kW]	[V]			[A]	[W]	[m]	[mm]	[kg]
4.9	3 AC 180 ... 550	E94APNE0104	E94AZRP0084	8.0	20	6 axes of 10 m each	485 x 60 x 261	4.2
17.5		E94APNE0364	E94AZRP0294	29.0	50			4.5
48.6		E94APNE1004	E94AZRP0824	82.0	80		490 x 209 x 272	18.5
119.0		E94APNE2454	E94AZRP2004	200.0	150			20.5

→ Data sheet on RFI filters

DS_9400_0003

Available for download at www.lenze.com/dsc



Mains filter

A mains filter is a combination of mains choke and RFI filter in one housing. It reduces line-bound noise emission into the mains, thus ensuring that the line-bound interference voltage is reduced to a permissible level according to EN61800-3.



Mains filter, can be mounted beside the power supply modules (right) or the regenerative power supply modules (left)

Mains filters for power supply modules

Rated power	Mains voltage	Product key		Rated current	Voltage drop	Max. cable length	Dimensions	Mass
With mains filter		Power supply module	Mains filter			Reference group C2		
P_N	U_{AC}			I_N	U	I_{max}	$h \times b \times t$	m
[kW]	[V]			[A]	[V]	[m]	[mm]	[kg]
4.9	3 AC 180 ... 550	E94APNE0104	E94AZMP0084	8.0	10.0	10 axes of 50 m each	485 x 90 x 261	8.6
17.5		E94APNE0364	E94AZMP0294	29.0	7.3		485 x 120 x 261	16.5
48.6		E94APNE1004	E94AZMP0824 ¹⁾	82.0	6.4		490 x 270 x 272	29.0
119.0		E94APNE2454	E94AZMP2004 ¹⁾	200.0	6.3		490 x 330 x 272	52.0

¹⁾ External 24 V supply from a safely separated power supply unit (SELV/PELV) required for integrated fan.

Mains filters for regenerative power supply modules

Rated power	Mains voltage	Product key		Rated current	Voltage drop	Max. cable length	Dimensions	Mass
With mains filter		Supply- / regenerative module	Mains filter			Reference group C2		
P_N	U_{AC}			I_N	U	I_{max}	$h \times b \times t$	m
[kW]	[V]			[A]	[V]	[m]	[mm]	[kg]
15.0	3 AC 180 ... 550	E94ARNE0134	E94AZMR0264SDB ⁻²⁾	26.0	6.3	6 axes of 10 m each	485 x 149 x 272	25.0
			E94AZMR0264LDB ⁻²⁾			10 axes of 50 m each		26.0
27.0		E94ARNE0244	E94AZMR0474SDB ⁻²⁾	47.0	6.2	6 axes of 10 m each	485 x 209 x 272	36.0
			E94AZMR0474LDB ⁻²⁾			10 axes of 50 m each		37.0

²⁾ External 24 V supply through safely separated power supply unit (SELV/PELV) required for integrated mains voltage recording.

→ Data sheet on mains filters
DS_9400_0004
 Available for download at www.lenze.de/dsc



Servo Drives 9400

Accessories

24 V power supply unit

Multi-axis applications with Multi Drive axis modules require an external power supply unit to feed the control electronics. Depending on the number of axis modules, power supply units with a rated current of 5, 10 or 20 A can be selected with a voltage supply of 1 x 230 V AC or 3 x 400 V AC. Single Drive axis modules generally do not require the use of the power supply unit. If, however, separate power supplies are needed for the control electronics and power section in a single-axis application, the same power supply units can be used.



24 V power supply unit

Rated data

Product key			EZV1200-000	EZV2400-000	EZV4800-000	EZV1200-001	EZV2400-001	EZV4800-001
Rated voltage	$U_{N, AC}$	[V]	230			400		
Rated mains current	$I_{N, AC}$	[A]	0.8	1.2	2.3	0.3	0.6	1.0
Output voltage	U_{out}	[V]	DC 22.5 ...28.5					
Rated current	I_N	[A]	5.0	10.0	20.0	5.0	10.0	20.0
Dimensions								
Height	h	[mm]				130		
Width	b	[mm]	55	85	157	73	85	160
Depth	t	[mm]				125		
Mass	m	[kg]	0.8	1.2	2.5	1.0	1.1	1.9

CAN bus connector

The connector is used to connect the CAN to those Lenze drives which are provided with a Sub-D connection for the CAN bus. An integrated CAN terminating resistor can be switched on/off. Internal spring terminals make the use of special mounting tools superfluous. The switch setting can be read from two sides.



CAN bus connector

Mode	Product key
CAN bus connector "switch"	EWZ0046



USB diagnostic adapter

Diagnostics can be performed via a PC by using the USB diagnostic adapter. A connecting cable, which can be connected to the PC's USB interface, is supplied with the adapter.

Connecting cables in three different lengths of 2.5 m, 5 m and 10 m can be purchased separately to connect the USB diagnostic adapter to the axis module.

The software drivers required for the operation of the adapter are installed automatically when the Lenze software (e.g. the L-force Engineer) is installed.



USB diagnostic adapter incl. connecting cable to the PC

Mode		Features	Slot	Product key
USB diagnostic adapter		<ul style="list-style-type: none"> ▶ Input-side voltage supply via USB connection on PC ▶ Output-side voltage supply via diagnostic interface of the inverter ▶ Diagnostic LED ▶ Electrical isolation of PC and inverter ▶ Hot-pluggable 	DIAG	E94AZCUS

Accessories for the USB diagnostic adapter

Mode	Features	Product key
Connecting cable for USB diagnostic adapter	▶ Length: 2.5 m	EWL0070
	▶ Length: 5 m	EWL0071
	▶ Length: 10 m	EWL0072



Servo Drives 9400 Accessories

X400 keypad

Local parameter setting and diagnostics can be performed very easily with the keypad. Data available in the drive can be accessed quickly via structured menus and a plain text display. The language selection feature means that the keypad can be used around the world. The keypad is attached to the front of the axis module.



X400 keypad

Mode		Features	Slot	Product key
X400 keypad		<ul style="list-style-type: none"> ▶ Menu navigation ▶ Graphics display with background lightning for clear presentation of information ▶ 4 navigation keys, 2 context-sensitive keys ▶ Adjustable RUN/STOP function ▶ Hot-pluggable ▶ Useable for L-force Inverter Drives 8400 and Servo Drives 9400 	DIAG	EZAEBK1001

Diagnosis terminal X400

Mode		Features	Slot	Product key
Diagnosis terminal X400		<ul style="list-style-type: none"> ▶ X400 keypad in a robust housing ▶ Also suitable for installation in the control cabinet door ▶ incl. 2.5 m cable ▶ IP20 enclosure, IP65 for control cabinet installation on front face ▶ Useable for L-force Inverter Drives 8400 and Servo Drives 9400 	DIAG	EZAEBK2001



Shield connection kits for motor cable

The motor cable shielding can be connected to the shield plates of the installation backplanes or axis modules. To simplify the wiring, additional shield supports can be fitted to the shield plates. The shield support can easily be attached to a fixture on the shield plate and the connection cable just has to be passed through. For larger axis modules the shield support is part of the shield plate.

Product key		Shield mounting
Single Drive	Multi Drive	
	E94AM□E0024	E94AZJS003
E94AS□E0024		
	E94AM□E0034	
E94AS□E0034		E94AZJS007
	E94AM□E0044	
E94AS□E0044		
	E94AM□E0074	E94AZJS007
E94AS□E0074		
	E94AM□E0094	
	E94AM□E0134	E94AZJS024
E94AS□E0134		
	E94AM□E0174	
E94AS□E0174		
	E94AM□E0244	
E94AS□E0244		E94AZJS024
	E94AM□E0324	

Other accessories

Lenze offers a number of other automation components for the Servo Drives 9400. They do not form part of this product catalogue, but can be found in the Controller-based Automation and PC-based Automation catalogues. More specifically, this relates to the following components:

- ▶ Controllers
- ▶ Industrial PCs
- ▶ Remote maintenance components
- ▶ IO systems
- ▶ Human Machine Interfaces
- ▶ System bus adapters



Servo Drives 9400 Modules

Overview of modules

For adaptation to the machine requirements, up to four different modules can be used to adjust the Servo Drives 9400 and regenerative power supply modules. The following slots are available:



- ▶ memory modules:
(slot MMI) required for operation,
- ▶ safety modules:
(slot MSI) required for operation
- ▶ extension modules:
(slot MXI 1 and/or MXI 2)



Axis module with module slots MXI, MMI and MSI



The tables below show the the modules available for Servo Drive 9400 and the regenerative power supply modules.

Memory module

Slot		Mode	Product key	Mode	
				HighLine	Regen. module
		Memory module			
MMI		Motion control HighLevel MM220	E94AYM22	Standard	Standard
MMI		Motion control TopLevel MM330	E94AYM33	Option	
MMI		Motion control TopLevel MM430	E94AYM43	Option	



Safety module

Slot		Mode		Product key	Mode	
		Safety module			HighLine	Regen. module
MSI		SM0		E94AYAA	Standard	Standard
MSI		SM100		E94AYAB	Option	
MSI		SM301		E94AYAE	Option	











Servo Drives 9400 Modules

Extension modules

Slot		Mode	Product key	Mode	
		Extension module		HighLine	Regen. module
MXI1 MXI2		Digital frequency	E94AYFLF	Option	

Communication modules

Slot		Mode	Product key	Mode	
		Communication module		HighLine	Regen. module
MXI1 MXI2		CANopen	E94AYCCA	Option	Option
MXI1 MXI2		DeviceNet	E94AYCDN	Option	Option
MXI1 MXI2		EtherCAT	E94AYCET	Option	Option
MXI1 MXI2		Ethernet	E94AYCEN	Option	Option
MXI1 MXI2		POWERLINK MN/CN	E94AYCEP	Option	
MXI1 MXI2		POWERLINK CN	E94AYCEC	Option	
MXI1 MXI2		PROFIBUS	E94AYCPM	Option	Option
MXI1 MXI2		PROFINET	E94AYCER	Option	Option



Assignment of extension modules and module slots (HighLine)

Two module slots on the Servo Drives 9400 are intended for extensions. The following table lists the possible combinations.

MXI 1	E94AYFLF	E94AYCCA	E94AYCDN	E94AYCET	E94AYCEN	E94AYCEP	E94AYCEC	E94AYCPM	E94AYCER
MXI 2									
E94AYFLF		•	•	•	•	•	•	•	•
E94AYCCA	•			•	•	•	•	•	•
E94AYCDN	•				•	•	•	•	•
E94AYCET	•	•			•				•
E94AYCEN	•	•	•	•		•	•	•	•
E94AYCEP	•	•	•		•			•	•
E94AYCEC	•	•	•		•				
E94AYCPM ¹⁾	•	•	•		•	•			•
E94AYCER ¹⁾	•	•	•	•	•	•		•	

¹⁾ Module slot MXI 1 must be used for PROFI-safe.

Assignment of extension modules and the module slot for the regenerative power supply module

Two module slots on the regenerative power supply modules are intended for extensions. The following table lists the possible combinations.

MXI 1	E94AYCCA	E94AYCDN	E94AYCET	E94AYCEN	E94AYCPM	E94AYCER
MXI 2						
E94AYCCA			•	•	•	•
E94AYCDN				•	•	•
E94AYCET	•	•		•		
E94AYCEN	•	•	•		•	•
E94AYCPM	•	•		•		
E94AYCER	•	•	•	•		



Servo Drives 9400 Modules

Memory module

Click – the plug-in memory module

For the Servo Drives 9400, various memory modules are available:



- ▶ Motion Control HighLevel (MM220)
- ▶ Motion Control TopLevel (MM330 and MM430)

With these modules, the functions described below are activated. The functions can be loaded into the drive with the help of L-force Engineer.

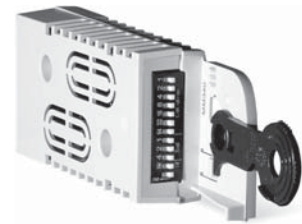
In addition to the different functions of the Runtime software versions, different memory sizes are available or, respectively, a real-time clock function (battery-backed), depending on the memory module used.



Memory module MM330

Mode		Features	Slot	Product key
Memory module				
Motion control HighLevel MM220		<ul style="list-style-type: none"> ▶ Application and parameter storage ▶ Functional range of HighLevel Motion Control with Servo Drives 9400 HighLine: <ul style="list-style-type: none"> - Speed actuating drive - Torque actuating drive - Electronic gearbox - Synchronism using mark synchronisation - Table positioning - Expansion/adaptation by means of function block editor In conjunction with regenerative power supply module: <ul style="list-style-type: none"> - operation of the regenerative power supply module - expansion/adaptation by means of function block editor ▶ Address switch and baud rate setting for onboard system bus CANopen 	MMI	E94AYM22
Motion control TopLevel MM330		<ul style="list-style-type: none"> ▶ Application and parameter storage ▶ Functional range of Motion Control TopLevel with Servo Drives 9400 HighLine: <ul style="list-style-type: none"> - Speed actuating drive - Torque actuating drive - Electronic gearbox - Synchronism using mark synchronisation - Table positioning - Positioning sequence control (graphical sequencer) - Expansion/adaptation by means of function block editor - Function blocks with cam functionality ▶ Address switch and baud rate setting for onboard system bus CANopen 	MMI	E94AYM33



Memory module

Mode		Features	Slot	Product key
Memory module				
Motion control TopLevel MM430		<ul style="list-style-type: none"> ▶ Application and parameter storage ▶ Functional range of Motion Control TopLevel with Servo Drives 9400 HighLine: <ul style="list-style-type: none"> - Speed actuating drive - Torque actuating drive - Electronic gearbox - Synchronism using mark synchronisation - Table positioning - Positioning sequence control (graphical sequencer) - Expansion/adaptation by means of function block editor - Function blocks with cam functionality ▶ Address switch and baud rate setting for onboard system bus CANopen ▶ Real-time clock (battery-buffered) 	MMI	E94AYM43

Product key		E94AYM22	E94AYM33	E94AYM43
Mode		Motion control HighLevel MM220	Motion control TopLevel MM330	Motion control TopLevel MM430
Storage medium	Flash memory [MB]	2.00	4.00	8.00
Additional function	Real-time clock	No		Yes
	System bus addressing switch (CAN)	Yes		



Servo Drives 9400 Modules

Safety module

Click – Safety integrated



For nearly every application, the provision of an extensive safety system is one of the most important tasks of the plant constructor. Frequently, this problem can only be solved with the help of complicated wiring. Thanks to the "Drive-based Safety" solution that can be integrated in servo drives 9400, this can be done by means of axis modules. The safety system, which can be integrated as an option, has a modular structure. The range of functions begins with the "safe torque off" function (formerly "safe standstill") and extends as far as integration in safety bus systems. The modular approach of Drive-based Safety also assures the ability to expand your system in the future and, at the same time, ensures flexibility.

The following modules are available with safety functions in accordance with IEC 61800-5-2:

- ▶ SM0 (necessary for the MSI slot if no safety functions are required)
- ▶ SM100
- ▶ SM301



Safety module SM301

Module		Features	Slot	Product key
Safety module				
SM0		<ul style="list-style-type: none"> ▶ No safety functions 	MSI	E94AYAA
SM100		<ul style="list-style-type: none"> ▶ 1 safe input for active sensors, 1 monitor (1-channel output) ▶ Control category 4 in acc. with EN 954-1, PL e in acc. with EN ISO 13849-1, SIL3 in acc. with EN IEC 62061 ▶ Safe torque off (STO) 		E94AYAB
SM301		<ul style="list-style-type: none"> ▶ 1 safe output, parameterisable ▶ 4 safe inputs, for active or passive sensors ▶ Safe torque off (STO) ▶ Safe stop 1 (SS1) ▶ Safe stop 2 (SS2)¹⁾ ▶ Safe operational stop (SOS)¹⁾ ▶ Safely limited speed (SLS)¹⁾ ▶ Safe maximum speed (SMS)¹⁾ ▶ Safe direction (SDI) of motion¹⁾ ▶ Operation mode selector (OMS) with confirmation (ES)¹⁾ ▶ Safe speed monitor (SSM)¹⁾ ▶ Safely limited increment (SLI)¹⁾ ▶ PROFIsafe safety bus via PROFIBUS DP and PROFINET IO (optional) ▶ Choice of 1-encoder or 2-encoder evaluation ▶ Control category 3 in acc. with EN 954-1, PL e in acc. with EN ISO 13849-1, SIL3 in acc. with EN IEC 62061 		E94AYAE

¹⁾ For speed-dependent safety functions, the motor-feedback system combinations listed on the following page are available.



Safety module

Product key			E94AYAA	E94AYAB	E94AYAE
Mode Safety module			SM0	SM100	SM301
Certification EN 954-1 EN ISO 13849-1 EN IEC 62061				Category 4 PLe SIL 3	Category 3 PLe SIL 3
Fail-safe state				Safe torque off	Safe torque off
Safe inputs/outputs Number of connectable active safety sensors Number of connectable passive safety sensors Monitor (1-channel output)				1 1	4, choice between active or passive 4, choice between active or passive
Safety bus PROFIsafe ¹⁾					PROFIBUS DP, PROFINET IO communication module (optional)
Diagnostics Status display				2 LEDs	6 LEDs
Rated voltage	$U_{N,DC}$	[V]		24.0	24.0

¹⁾ Module slot MXI 1 must be used for PROFIsafe.

Speed-dependent safety functions

For the following speed-dependent safety functions, the motor-feedback system combinations listed in the following table are available:

- ▶ Safe Stop 2 (SS2), Safe Operational Stop (SOS)
- ▶ Safely Limited Speed (SLS)
- ▶ Safe Maximum Speed (SMS)

- ▶ Safe Direction (SDI)
- ▶ Operation Mode Selector (OMS) with confirmation (ES)
- ▶ Safe Speed Monitor (SSM)
- ▶ Safely Limited Increment (SLI).

	Encoder type	Encoder type	Product key		Safe speed monitoring
Synchronous servo motors (MCS, MDXKS)	SinCos absolute value	Single-turn	AS1024-8V-H	2-encoder concept	PL d / SIL 2
		Multi-turn	AM1024-8V-H		
	Resolver		RS0		
Asynchronous servo motors (MCA, MQA)	SinCos incremental	Single-turn	IG1024-5V-V	2-encoder concept	PL e / SIL 3
	Resolver		RS0		PL d / SIL 2
					PL e / SIL 3
Three-phase AC motors (MD, MH, MF)	Resolver		RS1	2-encoder concept	PL d / SIL 2
					PL e / SIL 3

- ▶ A "2-encoder concept" is a resolver as motor feedback unit and, at the same time, an absolute value encoder (SinCos), and incremental encoder (TTL), an SSI encoder or bus encoder as position encoder at the machine



Servo Drives 9400 Modules

Extension module: digital frequency

Some applications require several axes to be operated in synchronism. What was formerly implemented by means of the line shaft, can now be achieved in the 9400 HighLine Servo Drives with the digital frequency extension module. The extension module provides a digital frequency input and output. The signals of the different axes can thus be looped through and simulated.



Extension module: digital frequency

Mode		Features	Slot	Product key
Extension module				
Digital frequency		<ul style="list-style-type: none"> ▶ Digital frequency 0 - 500 kHz ▶ Up to three slave drives connectable ▶ Sub-D connection for LFin and LOut 	MXI1 MXI2	E94AYFLF

Standards and operating conditions

Product key			E94AYFLF
Mode			Digital frequency
Enclosure			IP20
Vibration resistance			Amplitude/Acceleration Acceleration resistant up to 0.7 g acc, to Germanischer Lloyd 10 Hz ≤ f ≤ 57 Hz: ± 0.075 mm amplitude, Sinusoidal vibration
Site altitude Amsl	H _{max}	[m]	4000
Climatic conditions			1K3 (temperature: -25 °C ... +60 °C) 2K3 (temperature: -25 °C ... +70 °C) 3K3 (temperature: -10°C ... +55°C)
Insulation voltage to reference earth/PE	U _{AC}	[V]	50.0



Extension module: digital frequency

Product key			E94AYFLF
Mode			
System cables			Type: EYD
Digital frequency			
Input	f	[kHz]	0 to 500 (TTL)
Output	f	[kHz]	0 to 500 (TTL)
Feedback			
Incremental encoder type			TTL encoder
Incremental encoder signal			2 signals of 5 V offset by 90°
Sequence connections			
In parallel			3 drives
In series			For 250 kHz 20 drives For 500 kHz 10 drives
Rated voltage	$U_{N,DC}$	[V]	24.0



Servo Drives 9400 Modules

Communication module CANopen

The Servo Drives 9400 HighLine and the regenerative power supply modules have a CANopen interface on board as a standard feature. It enables the axis modules to communicate with each other and with other system bus components (e.g. I/O systems or HMIs).

If a second CANopen interface is necessary for system networking, the CANopen communication module can be used for this purpose. CANopen is a communication protocol based on CAN physics. Its specifications are determined by the CiA user group (CAN in Automation). Compatibility with the Lenze system bus (CAN) can be established by means of configuration.



Communication module CANopen

Mode		Features	Slot	Product key
Communication module				
CANopen		<ul style="list-style-type: none"> ▶ Automatic baud rate detection ▶ CANopen profile DS301, V4.02 Lenze system bus ▶ 2 LEDs for communication status display ▶ Sub-D connection ▶ DIP switch for selecting baud rate and address 	MX11 MX12	E94AYCCA

Standards and operating conditions

Product key			E94AYCCA
Mode Communication module			CANopen
Enclosure EN 60529			IP20
Vibration resistance			Amplitude/Acceleration Acceleration resistant up to 0.7 g acc, to Germanischer Lloyd 10 Hz ≤ f ≤ 57 Hz: ± 0.075 mm amplitude, 5 Hz ≤ f ≤ 13.2 Hz ± 1 mm amplitude, 13.2 Hz ≤ f ≤ 100 Hz: Sinusoidal vibration
Site altitude Amsl	H _{max}	[m]	4000
Climatic conditions Storage (EN 60721-3-1) Transport (EN 60721-3-2) Operation (EN 60721-3-3)			1K3 (temperature: -25 °C ... +60 °C) 2K3 (temperature: -25 °C ... +70 °C) 3K3 (temperature: -10 °C ... +55 °C)
Insulation voltage to reference earth/PE	U _{AC}	[V]	50.0



Communication module CANopen

Product key			E94AYCCA
Communication Medium Communication profile			DIN ISO 11898 CANopen, DS301 V4.02 Lenze system bus
Baud rate		[kBit / s]	10 20 50 125 250 500 800 1000
Node			Multi-master Slave
Network topology			Line with terminating resistors (120 ohm) at both ends
Number of logical process data channels			4 (each with 1 - 8 bytes)
Number of logic parameter data channels			5
Number of bus nodes			127 110 (no repeaters)
Max. cable length between two nodes per bus segment	I_{max} I_{max}	[m] [m]	100 17 for 1000 kbps 40 for 800 kbps 110 for 500 kbps 290 for 250 kbps 630 for 125 kbps 1500 for 50 kbps 3900 for 20 kbps 8000 for 10 kbps
Rated voltage	$U_{N,DC}$	[V]	24.0

¹⁾ Max. bus cable lengths also depend on the number of nodes and the cable cross-section used.



Servo Drives 9400 Modules

Communication module DeviceNet

The American automation specialist Allan Bradley developed the DeviceNet fieldbus based on the CAN controller. This communication profile is published by the ODVA (Open DeviceNet Vendor Association) user organisation. A large number of sensors and actuators are available. Similar to CANopen, a DeviceNet master is used to control the DeviceNet.



Communication module DeviceNet

Mode		Features	Slot	Product key
Communication module				
DeviceNet		<ul style="list-style-type: none"> ▶ "Group 2 Only Server" functionality (slave) ▶ 1 LED for communication status display ▶ DIP switch for selecting baud rate and address ▶ Push-on terminal strip with screw connection, 5-pin 	MXI1 MXI2	E94AYCDN

Standards and operating conditions

Product key			E94AYCDN
Mode Communication module			DeviceNet
Enclosure EN 60529			IP20
Vibration resistance			Amplitude/Acceleration Acceleration resistant up to 0.7 g acc, to Germanischer Lloyd 10 Hz ≤ f ≤ 57 Hz: ± 0.075 mm amplitude, Sinusoidal vibration
Site altitude Amsl	H _{max}	[m]	4000
Climatic conditions Storage (EN 60721-3-1) Transport (EN 60721-3-2) Operation (EN 60721-3-3)			1K3 (temperature: -25 °C ... +60 °C) 2K3 (temperature: -25 °C ... +70 °C) 3K3 (temperature: -10°C ... +55°C)
Insulation voltage to reference earth/PE	U _{AC}	[V]	50.0



Communication module DeviceNet

Product key			E94AYCDN
Communication Medium			DIN ISO 11898
Communication profile			DeviceNet
Baud rate		[kBit / s]	125 250 500
Node			Slave
Network topology			Line with terminating resistors (120 ohm) at both ends
Process data words (PCD)			32
Number of bus nodes			max. 64
Max. cable length per bus segment	I_{max}	[m]	100 for 125 kbps, Thin Cable 100 for 250 kbps, Thin Cable 100 for 500 kbps, Thick Cable 100 for 500 kbps, Thin Cable 250 for 250 kbps, Thick Cable 500 for 125 kbps, Thick Cable
Rated voltage	$U_{N,DC}$	[V]	24.0



Servo Drives 9400 Modules

Communication module EtherCAT

Physically speaking, EtherCAT is a ring system that uses a one-total-frame protocol, where the device manipulates the data during the cycle. It has two physical variants, the E-bus and Ethernet. E-bus is only suitable for short distances within a device; only the Ethernet version offers the benefits of an Ethernet system.



Communication module EtherCAT

Mode		Features	Slot	Product key
Communication module				
EtherCAT		<ul style="list-style-type: none"> ▶ CANopen over EtherCAT (CoE) ▶ Distributed clock ▶ 2 RJ45 connections with LEDs for link/activity ▶ 2 LEDs for communication status display ▶ External voltage supply possible 	MXI1 MXI2	E94AYCET

Standards and operating conditions

Product key			E94AYCET
Mode Communication module			EtherCAT
Enclosure EN 60529			IP20
Vibration resistance			Amplitude/Acceleration Acceleration resistant up to 0.7 g acc, to Germanischer Lloyd 10 Hz ≤ f ≤ 57 Hz: ± 0.075 mm amplitude, Sinusoidal vibration
Site altitude Amsl	H _{max}	[m]	4000
Climatic conditions Storage (EN 60721-3-1) Transport (EN 60721-3-2) Operation (EN 60721-3-3)			1K3 (temperature: -25 °C ... +60 °C) 2K3 (temperature: -25 °C ... +70 °C) 3K3 (temperature: -10°C ... +55°C)
Insulation voltage to reference earth/PE	U _{AC}	[V]	50.0



Communication module EtherCAT

Product key			E94AYCET
Communication Medium			CAT5e S/FTP according to ISO/ICE11801 (2002)
Communication profile			CoE (CANopen over EtherCAT)
Baud rate		[MBit / s]	100
Node			Slave
Network topology			Line (internal ring)
Number of logical process data channels			1
Process data words (PCD)			1 ... 32
16 Bit			
Number of bus nodes			max. 65535
Max. cable length between two nodes	I_{\max}	[m]	100
Rated voltage	$U_{N,DC}$	[V]	24.0



Servo Drives 9400 Modules

Communication module Ethernet

Initially the Ethernet network was reserved for the office, but today this communication system is also often used for system parameterisation. The 9400 Servo Drives can be expanded for this purpose using an Ethernet module.

The Ethernet module can be integrated into general IT infrastructures (e.g. control centres, production data acquisition) and is suitable for remote maintenance applications. It is intended for parameter setting, but not for real-time transmission of process data.



Communication module Ethernet

Mode		Features	Slot	Product key
Communication module				
Ethernet		<ul style="list-style-type: none"> ▶ 2 RJ45 connections with LEDs for link/activity ▶ Automatic setting of baud rate and transmission mode ▶ Automatic detection of wiring errors and polarity reversal ▶ Integrated 2-port switch ▶ Automatic switching between transmit and receive paths (autocrossing) ▶ Electrically isolated from the bus 	MXI1 MXI2	E94AYCEN

Standards and operating conditions

Product key			E94AYCEN
Mode Communication module			Ethernet
Enclosure EN 60529			IP20
Vibration resistance			Amplitude/Acceleration Acceleration resistant up to 0.7 g acc, to Germanischer Lloyd 10 Hz ≤ f ≤ 57 Hz: ± 0.075 mm amplitude, Sinusoidal vibration
Site altitude Amsl	H _{max}	[m]	4000
Climatic conditions Storage (EN 60721-3-1) Transport (EN 60721-3-2) Operation (EN 60721-3-3)			1K3 (temperature: -25 °C ... +60 °C) 2K3 (temperature: -25 °C ... +70 °C) 3K3 (temperature: -10°C ... +55°C)
Insulation voltage to reference earth/PE	U _{AC}	[V]	50.0



Communication module Ethernet

Product key			E94AYCEN
Communication Medium			Twisted Pair, CAT5e to IEEE802.3
Communication profile			GCI, based on TCP/IP
Baud rate		[MBit / s]	100
Signalling			Activity Link
Network topology			Star Use of hubs/switches
Transmission Mode			Half duplex/full duplex
Rated voltage	$U_{N,DC}$	[V]	24.0





Servo Drives 9400 Modules

Communication module ETHERNET Powerlink

ETHERNET Powerlink (EPL) is an Ethernet-based bus system which also makes use of the tried-and-tested CANopen standards. Any CANopen drive profile can be transferred directly to the EPL context without the need for any adaptations. ETHERNET Powerlink is suitable for control/inverter networking, for pure PLC functionality and for motion control systems. The managing node (MN) takes care of the bus master functionality and the slaves are referred to as controlled nodes (CN).



Communication module ETHERNET Powerlink

Mode		Features	Slot	Product key
Communication module				
POWERLINK MN/CN		<ul style="list-style-type: none"> ▶ 2 RJ45 connections with LEDs for link/activity ▶ Managing node (MN) or controlled node (CN) ▶ 2 LEDs for communication status display ▶ Integrated hub ▶ External voltage supply possible 	MXI1 MXI2	E94AYCEP
POWERLINK CN		<ul style="list-style-type: none"> ▶ 2 RJ45 connections with LEDs for link/activity ▶ 2 LEDs for communication status display ▶ Integrated hub ▶ Controlled node (CN) ▶ External voltage supply possible 	MXI1 MXI2	E94AYCEC

Standards and operating conditions

Product key			E94AYCEP	E94AYCEC
Mode			POWERLINK MN/CN	POWERLINK CN
Communication module				
Enclosure EN 60529			IP20	
Vibration resistance			Amplitude/Acceleration Acceleration resistant up to 0.7 g acc, to Germanischer Lloyd $10 \text{ Hz} \leq f \leq 57 \text{ Hz}$: $\pm 0.075 \text{ mm}$ amplitude, Sinusoidal vibration	
Site altitude Amsl	H_{\max}	[m]	4000	
Climatic conditions			1K3 (temperature: $-25 \text{ }^\circ\text{C} \dots +60 \text{ }^\circ\text{C}$) 2K3 (temperature: $-25 \text{ }^\circ\text{C} \dots +70 \text{ }^\circ\text{C}$) 3K3 (temperature: $-10 \text{ }^\circ\text{C} \dots +55 \text{ }^\circ\text{C}$)	
Storage (EN 60721-3-1)				
Transport (EN 60721-3-2)				
Operation (EN 60721-3-3)				
Insulation voltage to reference earth/PE	U_{AC}	[V]	50.0	



Communication module ETHERNET Powerlink

Product key			E94AYCEP	E94AYCEC
Communication Medium			CAT5e S/FTP according to ISO/ICE11801 (2002)	
Communication profile			EPL2.0	
Baud rate		[MBit / s]	100	
Node			Controlled node (CN) Managing node (MN)	Controlled node (CN)
Network topology			Star If using the external hubs Line If using the internal hubs	
Number of bus nodes			240	
Max. cable length between two nodes	I_{max}	[m]	100	
Rated voltage	$U_{N,DC}$	[V]	24.0	

ETHERNET Powerlink hub

Lenze offers an external 8-fold hub supplementing the 2-fold hub integrated in the ETHERNET Powerlink interface module. This infrastructure component corresponds to a class-II repeater according to IEEE802.3u. It automatically detects the network baud rate (10 or 100 Mbps). The hubs can be cascaded via a special uplink port.



ETHERNET Powerlink hub

Mode		Features	Product key
Communication module			
Powerlink Hub		<ul style="list-style-type: none"> ▶ Automatic baud rate detection (10/100 Mbps) ▶ DC 24 V ▶ 8-fold hub in industrial design ▶ Cascadable 	E94AZCEH



Servo Drives 9400 Modules

Communication module PROFIBUS

One of the communication channels most commonly used in industry is PROFIBUS. The 9400 Servo Drives series is provided with the corresponding interface module required for this type of communication.

The PROFIBUS module is a slave connection module with the PROFIBUS-DP communication profile. It is used for networking between the control and the inverter at high processing speeds. It provides a user-friendly way of integrating the inverter into the overall system network.



Communication module PROFIBUS

Mode		Features	Slot	Product key
Communication module				
PROFIBUS		<ul style="list-style-type: none"> ▶ 2 LEDs for communication status display ▶ Address can be set by means of a DIP switch ▶ Electrically isolated from the bus ▶ Compatibility switch for communication module EMF2133 IB 	MXI1 MXI2	E94AYCPM

Standards and operating conditions

Product key			E94AYCPM
Mode Communication module			PROFIBUS
Enclosure EN 60529			IP20
Vibration resistance			Amplitude/Acceleration Acceleration resistant up to 0.7 g acc, to Germanischer Lloyd 10 Hz ≤ f ≤ 57 Hz: ± 0.075 mm amplitude, Sinusoidal vibration
Site altitude Amsl	H _{max}	[m]	4000
Climatic conditions Storage (EN 60721-3-1) Transport (EN 60721-3-2) Operation (EN 60721-3-3)			1K3 (temperature: -25 °C ... +60 °C) 2K3 (temperature: -25 °C ... +70 °C) 3K3 (temperature: -10°C ... +55°C)
Insulation voltage to reference earth/PE	U _{AC}	[V]	50.0



Communication module PROFIBUS

Product key			E94AYCPM
Communication Medium			RS 485, shielded twisted pair
Communication profile			PROFIBUS-DP-V0 PROFIBUS-DP-V1 PROFIsafe
Device profile			Lenze device control
Baud rate		[kBit / s]	9.6 ... 12 000 (automatic detection)
Node			Slave
Network topology			with repeater: Line or tree without repeater: Line
Process data words (PCD) 16 Bit			1 ... 32
DP user data length			Optional parameter channel (4 words) + process data words
Number of bus nodes			31 slaves + 1 master per bus segment With repeaters: 125
Max. cable length per bus segment	I_{max}	[m]	1200 (depending on the baud rate and the cable type used)
Rated voltage	$U_{N,DC}$	[V]	24.0



Servo Drives 9400 Modules

Communication module PROFINET

The PROFINET bus system based on Ethernet is often used as the successor of PROFIBUS. There are several variants of the PROFINET which differ regarding the deterministics and thus the cycle times possible. The most frequent variant of the PROFINET I/O is the RT variant which can be used for control/inverter networking but not for motion control applications.



Communication module PROFINET

Mode		Features	Slot	Product key
Communication module				
PROFINET		<ul style="list-style-type: none"> ▶ 2 RJ45 connections with LEDs for link and activity ▶ 2 LEDs for communication status display ▶ Integrated 2-port switch ▶ PROFINET I/O device ▶ Soft Real Time (RT) ▶ External voltage supply possible 	MXI1 MXI2	E94AYCER

Standards and operating conditions

Product key			E94AYCER
Mode Communication module			PROFINET
Enclosure EN 60529			IP20
Vibration resistance			Amplitude/Acceleration Acceleration resistant up to 0.7 g acc, to Germanischer Lloyd 10 Hz ≤ f ≤ 57 Hz: ± 0.075 mm amplitude, Sinusoidal vibration
Site altitude Amsl	H _{max}	[m]	4000
Climatic conditions Storage (EN 60721-3-1) Transport (EN 60721-3-2) Operation (EN 60721-3-3)			1K3 (temperature: -25 °C ... +60 °C) 2K3 (temperature: -25 °C ... +70 °C) 3K3 (temperature: -10°C ... +55°C)
Insulation voltage to reference earth/PE	U _{AC}	[V]	50.0



Communication module PROFINET

Product key			E94AYCER
Communication Medium Communication profile			CAT5e S/FTP according to ISO/ICE11801 (2002) PROFINET I/O (RT) PROFIsafe in combination with SM301
Baud rate		[kBit / s]	100
Node			PROFINET I/O device
Network topology			Star Use of switches
Process data words (PCD) 16 Bit			1 ... 32
Max. cable length between two nodes	I_{max}	[m]	100
Rated voltage	$U_{N,DC}$	[V]	24.0

General information

The L-force Engineer is the engineering tool for the configuration, commissioning and diagnostics of all L-force products. With its intuitive user interface and transparent dialog boxes, the L-force Engineer has been tailored to meet the needs of the user.

The main navigation structure sorts essential functions into various transparent views. Graphical interfaces simplify the configuration and parameterisation processes for the devices. Multi-device engineering comes naturally with the L-force Engineer StateLevel and HighLevel.

The following options are available:

- ▶ **Engineer StateLevel**
Featuring all the necessary diagnostic functions, this product is ideal for service engineers and commissioners. Smaller projects involving up to five target systems can be implemented using this free version of the software.
- ▶ **Engineer HighLevel**
Engineer HighLevel is the full version of the software. Single user, multiple user, corporate or buyout licences are available.
In addition to the functional scope supported by the Engineer StateLevel, this version includes functions for large-scale projects. You can set up networks, interconnect communication and use the function block editor, to name but a few of the available features. The Engineer project even supports machine documentation. In short, you have access to a central source where you can find everything you need, whenever you need it – in next to no time.

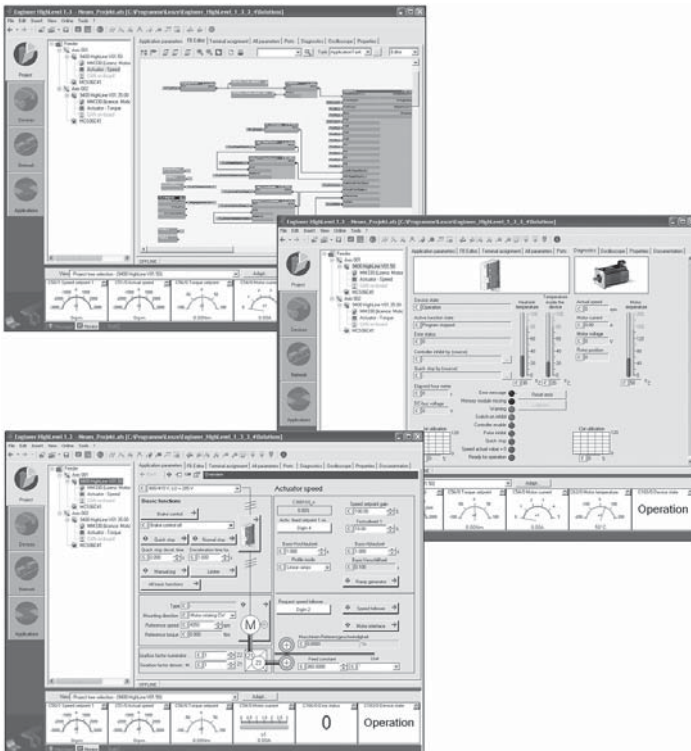

User interfaces of L-force Engineer



Functions and features

The following table describes functions and features of L-force Engineer:

Since not all functions can be accessed by every drive, the engineering software appears differently, depending on the selected drive.

Mode	L-force Engineer StateLevel	L-force Engineer HighLevel
Drives and components	8400 Inverter Drives Servo Drives 9400 I/O system 1000, I/O system IP20 Lenze motors User motors	
Project creation	Limitation to 5 target systems	Unlimited
Project documentation	Stored in project	
Parameter setting	Graphics-based Parameter list	
Networks and communication		CAN network configuration Network configuration for ETHERNET Powerlink Communication interconnection Port editor (communication interface) Creation of machine application
Configuration		Function block editor
Diagnostics	Terminal display/diagnostics overview Monitor window Logbook of all error messages Online values in graphics-based parameterisation Online/offline comparison Oscilloscope: 2-channel	Terminal display/diagnostics overview Monitor window Logbook of all error messages Online values in graphics-based parameterisation Online values in function block editor Network diagnostics Online/offline comparison Oscilloscope: 8-channel
Safety	Safe configuration of SM301	
Cam		Cam Editor Import, graphical entry Straight line, 5th order polynomial and sloped sine line Automatic extension of profiles with integrated export system and AddOn Cam Designer
Technology applications	Speed actuating drive Torque actuating drive Electronic gearbox Synchronism with mark registration Positioning (table positioning, positioning sequence control)	



Data access/communication

The following table describes the communication paths of the engineering software to the connected drives. Some drives do not support all communication paths, so that some communication paths may not be possible.

Communication	
CAN	USB connection via USB system bus adapter EMF2177IB Parallel interface with system bus adapter EMF2173IB ¹⁾
Ethernet	Network connection (10/100 Mbps Ethernet) switch or hub recommended
L-force diagnostic interface	USB connection with diagnostic adapter E94AZCUS

¹⁾ For connection to the Servo Drives 9400, an EWZ0046 connector is necessary.

System requirements

System requirements for L-force Engineer State-Level/HighLevel

The following minimum hardware and software requirements must be met in order to be able to work with the L-force Engineer:

- ▶ Microsoft®Windows® 2000 SP4 or higher + Rollup pack1 /XP 32 bit SP3 or higher / Windows 7 32 bit
- ▶ IBM-compatible PC with Intel® Pentium® processor 1.4 GHz (projects up to a maximum of 5 axes 750 MHz and higher)
- ▶ Min. 1 MB main memory (RAM), (projects up to a maximum of 5 axes min. 512 MB)
- ▶ Min. 2 GB free hard disk space
- ▶ Min. 1.024 x 768 pixels screen resolution with 256 display colours
- ▶ Mouse
- ▶ CD-ROM drive
- ▶ Free slots/ports meeting the requirements of the individual fieldbus interface module

L-force Loader

The L-force Loader makes standard set-up much easier to perform. Finished L-force projects can be transferred from the PC to the device directly. The L-force Loader cannot be used to make any changes to these projects.

You can obtain the L-force Loader free of charge from the Internet at www.Lenze.de.

Cam Designer

You can use the Cam Designer to create and optimise motion profiles and cam groups for electronic cams quickly and intuitively. Whether you are importing data, using CAD or entering the profiles directly, the Cam Designer will support you from the very first step. Motion profiles can be entered really easily using the mouse and a graphical user interface.

Features:

- ▶ Fast entry of the relevant parts of the motion profile
- ▶ Clear overview of all motion profiles of other tools
- ▶ Complex motion tasks divided into several simple indexing movements
- ▶ The Cam Manager program is integrated for simple management of all drives, curves and cams



Overview of licences

Single user licence

Single user licences are always supplied with the software product on CD-ROM. The purchaser is entitled to install the software product on his/her PC. Multiple installations on different PCs are not permitted.

Multiple user licence

Some software products can be supplied with multiple user licences. When you purchase this licence, you acquire the right to install a specific software product (CD-ROM with single user licence) on the number of machines for which licences have been purchased. A legally valid single user licence must be held before multiple user licences can be purchased.

Corporate licence

Software products with corporate licences need only be purchased once. These products may be installed on multiple machines within a company on a single site. In such cases, additional multiple user licences are not required.

Buyout licence

A buyout licence permits multiple installations of the software within a company on a single site. Purchasers of buyout licences are also entitled to issue sublicences for machines in which Lenze devices are installed.

Selection and order data

Mode	Features	Product key
L-force Engineer StateLevel, freeware	<ul style="list-style-type: none"> Order free of charge Download via the Internet Languages: German/English/French 	Download free of charge
L-force Engineer HighLevel, single user licence	<ul style="list-style-type: none"> CD-ROM included in scope of supply Installation on one PC Includes GDC, GD Loader and GD Oscilloscope Languages: German/English/French 	ESPEVEHXAOEC1
L-force Engineer HighLevel, multiple user licence	<ul style="list-style-type: none"> CD-ROM not included in scope of supply Multiple installations on the number of machines for which licences have been purchased The basis is a single user licence 	ESPEVEHNNMML1
L-force Engineer HighLevel, corporate licence	<ul style="list-style-type: none"> CD-ROM not included in scope of supply Multiple installations within a company at one location The basis is a single user licence 	ESPEVEHNNNFL1
L-force Engineer HighLevel, buyout licence	<ul style="list-style-type: none"> CD-ROM not included in scope of supply Multiple installations within a company at one location Issuing of sublicences in conjunction with Lenze drives installed in a machine The basis is a single user licence 	ESPEVEHNNNBL1
Upgrade from GDC to L-force Engineer HighLevel single user licence	<ul style="list-style-type: none"> CD-ROM included in scope of supply Installation on one PC The basis is a GDC licence Languages: German/English/French 	ESPEGEHXAOEC1
Upgrade from GDC to L-force Engineer HighLevel multiple user licence	<ul style="list-style-type: none"> Multiple installations on the number of machines for which licences have been purchased CD-ROM included in scope of supply The basis is a GDC and Engineer HighLevel single user licence 	ESPEGEHNNMML1
Upgrade from GDC to L-force Engineer HighLevel company licence	<ul style="list-style-type: none"> CD-ROM not included in scope of supply Multiple installations within a company at one location The basis is a GDC and Engineer HighLevel single user licence 	ESPEGEHNNNFL1
Upgrade from GDC to L-force Engineer HighLevel buyout licence	<ul style="list-style-type: none"> CD-ROM not included in scope of supply Multiple installations within a company at one location Issuing of sublicences in conjunction with Lenze drives installed in a machine The basis is a GDC and Engineer HighLevel single user licence 	ESPEGEHNNNBL1

Mode	Features	Product key
Cam Designer, single user licence	<ul style="list-style-type: none"> CD-ROM included in scope of supply Installation on one PC Languages: German/English/French 	ESP-CAM1-P
Cam Designer V 2.3 upgrade to Cam Designer V 3.x	<ul style="list-style-type: none"> Upgrade to Cam Designer V 3.0 Multiple user licence 	ESP-CAM1-PU2

Lenze SE
Postfach 10 13 52
D-31763 Hameln
Telefon +49 (0)51 54 / 82-0
Telefax +49 (0)51 54 / 82-28 00
E-Mail: Lenze@Lenze.de
Internet: www.Lenze.com

Lenze Automation GmbH
Grünstraße 36, D-40667 Meerbusch
Telefon +49 (0)21 32 / 99 04-0
Telefax +49 (0)21 32 / 7 21 90

Standort:
Hans-Lenze-Straße 1, D-31855 Aerzen
Postfach 101352, D-31763 Hameln
Telefon +49 (0)51 54 / 82-0
Telefax +49 (0)51 54 / 82-28 00
Standort:
Am Alten Bahnhof 11
D-38122 Braunschweig
Telefon +49 (0)531 / 80178-0
Telefax +49 (0)531 / 80178-20

Lenze Drives GmbH
Postfach 10 13 52, D-31763 Hameln
Breslauer Strasse 3, D-32699 Extertal
Telefon +49 (0)51 54 / 82-0
Telefax +49 (0)51 54 / 82-28 00

Lenze Operations GmbH
Postfach 10 13 52, D-31763 Hameln
Hans Lenze Straße 1, D-31855 Aerzen
Telefon +49 (0)51 54 / 82-0
Telefax +49 (0)51 54 / 82-28 00

Lenze GmbH & Co KG Anlagenbau
Buchenweg 1
D-31855 Aerzen
Telefon +49 (0)51 54 / 82-0
Telefax +49 (0)51 54 / 82-21 00

Lenze Service GmbH
Breslauer Straße 3
D-32699 Extertal
Mechanical Drives
Telefon +49 (0)51 54 / 82-16 26
Telefax +49 (0)51 54 / 82-13 96

Electronic Drives
Telefon +49 (0)51 54 / 82-11 11
Telefax +49 (0)51 54 / 82-11 12

Service Helpline
+49 (0)180 5 20 24 26

Lenze Verbindungstechnik GmbH
Ipf-Landesstraße 1
A-4481 ASTEN
Telefon +43 (0)72 24 / 210-0
Telefax +43 (0)72 24 / 210-998

Lenze DETO Drive Systems GmbH & Co KG
Untere Sparchen 16
A-6330 Kufstein
Telefon +43 (0)53 72 / 6 53 15-200
Telefax +43 (0)53 72 / 6 53 15-299

Schmidhauser AG
Obere Neustrasse 1
CH-8590 Romanshorn
Telefon +41 (0)71 466 11 11
Telefax +41 (0)71 466 11 10

encoway GmbH
Buschhöhe 2
D-28357 Bremen
Telefon +49 (0)4 21 / 33003 - 500
Telefax +49 (0)4 21 / 33003 - 555

DEUTSCHLAND/GERMANY

Lenze Vertrieb GmbH *
Ludwig-Erhard-Straße 52-56
D-72760 Reutlingen
Telefon +49 (0)71 21 / 9 39 39-0
Telefax +49 (0)71 21 / 9 39 39-29

Region Nord
HefeHof 25
31785 Hameln
Telefon (0 51 54) 82 44-0
Telefax (0 51 54) 82 44-44

Region West
Postfach 10 12 20
47497 Neukirchen-Vluyn
Kelvinstraße 7
47506 Neukirchen-Vluyn
Telefon (0 28 45) 95 93-0
Telefax (0 28 45) 95 93 93

Region Mitte/Ost
Postfach 1463
35724 Herbborn
Austraße 81
35745 Herbborn
Telefon (0 27 72) 95 94-0
Telefax (0 27 72) 95 94 94

Region Südwest
Postfach 14 33
71304 Waiblingen
Schänzle 8
71332 Waiblingen
Telefon (0 71 51) 9 59 81-0
Telefax (0 71 51) 9 59 81 50

Region Süd
Fraunhoferstraße 16
82152 Martinsried
Telefon (0 89) 89 56 14-0
Telefax (0 89) 89 56 14 14

WELTWEIT/WORLDWIDE

ALGERIA
see FRANCE

ARGENTINA *
E.R.H.S.A.
Girardot 1368, 1427 BUENOS AIRES
Phone +54 (0)11 / 45 54 32 32
Telefax +54 (0)11 / 45 52 36 11

AUSTRALIA *
FCR Motion Technology Pty. Ltd.
Unit 6, Automation Place
38-40 Little Boundary Rd.
LAVERTON NORTH, Vic. 3026
Phone +61 (3) 9362 6800
Telefax +61 (3) 9314 3744

AUSTRIA *
Lenze Antriebstechnik GmbH
Ipf-Landesstraße 1
4481 ASTEN
Phone +43 (0)7224 / 210-0
Telefax +43 (0)7224 / 210-999
Office Dornbirn:
Lustenauer Straße 64
6850 DORNBRN
Phone +43 (0)7224 / 210-0
Telefax +43 (0)7224 / 210-7299
Office Wr. Neudorf:
Triester Straße 14/109
2351 WR. NEUDORF
Phone +43 (0)7224 / 210-0
Telefax +43 (0)7224 / 210-7099

Office Graz:
Seering 8
8141 UNTERPREMSTÄTTEN
Phone +43 (0)7224 / 210-0
Telefax +43 (0)7224 / 210-7199
Lenze Verbindungstechnik GmbH
Ipf-Landesstraße 1
4481 ASTEN
Phone +43 (0)7224 / 210-0
Telefax +43 (0)7224 / 210-998
Lenze Anlagentechnik GmbH
Mühlenstraße 3
4470 ENNS
Phone +43 (0)7224 / 210-0
Telefax +43 (0)7224 / 210-997

BELARUS
see POLAND

BELGIUM *
Lenze bv.ba
Industriepark Noord, 19.
9100 SINT-NIKLAAS
Phone +32 (0)3.542.62.00
Telefax +32 (0)3.541.37.54

BOSNIA-HERZEGOVINA
see AUSTRIA

BRAZIL *
Lenze Brasil Automação Ltda.
Rua Conde Moreira Lima 589
CEP 04384-030
SÃO PAULO/SP – Brasil
Phone +55 11 2348-6579
Telefax +55 11 2348-6573

Produtos Eletrônicos Metaltext Ltda (Focus on Sales)
Rua José Rafaelli, 221
Socorro, CEP 04763-280
SÃO PAULO/SP – Brasil
Phone +55 11 56 83 57 00
Telefax +55 11 55 24 23 24

BULGARIA
Lenze Zadvizhvasta Tehnika EOOD
Bul. Maritza 21, Office 204
4003 PLOVDIV
Phone +359 / 32 / 940 373
Telefax +359 / 32 / 940 349

CANADA *
Lenze Canada Corporation
1535 Meyerside Drive, Unit 1
Mississauga, ON L5T 1M9 CANADA
Phone +1 (508) 278-9100
Telefax +1 (508) 278-7873

CENTRAL AMERICA
see Americas HQ

CHILE
Sargent S.A.
Tecnica Thomas C. Sargent
Av. Gral. Velásquez 5720, San Bernardo
SANTIAGO – CHILE
Phone +56 (0)2 / 51 03 000
Telefax +56 (0)2 / 69 83 989

CHINA *
Lenze Drive Systems (Shanghai) Co. Ltd.
No. 2989, Jiangshan Road
Lingang, Shanghai 201306
CHINA
Phone +86 21 3828 0200
Telefax +86 21 3828 0250

COLOMBIA
Casa Sueca, S.A.
Calle 52 1N-74
CALI
Phone +57 -2- 682 0444
Telefax +57 -2- 683 1411

CROATIA
Lenze mehatronika-pogonska tehnika d.o.o.
Ulica grada Gospića 3
HR-10000 ZAGREB
Phone +385 1 249-8056
Telefax +385 1 249-8057

CZECH REPUBLIC
Lenze, s.r.o.
Central Trade Park D1
396 01 HUMPOLEC
Phone +420 565 507-111
Telefax +420 565 507-399
Büro Červený Kostelec:
17. listopadu 510
549 41 ČERVENÝ KOSTELEČ
Phone +420 491 467-111
Telefax +420 491 467-166

DENMARK *
Lenze A/S
Vallensbækvej 18A
2605 BRØNDØY
Phone +45 / 4696 6666
Telefax +45 / 4696 6660
24 stunde service +45 / 5251 6699

Buero Jylland: Lenze A/S
Niels Bohrs Vej 23
8660 SKANDERBORG
Phone +45 / 46 96 66 88
Telefax +45 / 46 96 66 80

EGYPT
WADI Co. for technologies
and development
P.O.Box 209, new center Ramses
11794 CAIRO, Egypt
11 Syria St., Mohandessin
GIZA, Egypt
Phone +2 (02) 3347 6842
Telefax +2 (02) 3347 6843

ESTONIA
see FINLAND

FINLAND *
Lenze Drives
Tierankatu 8, 20520 TURKU
Phone +358 2 2748 180
Telefax +358 2 2748 189

FRANCE *
Lenze S.A.
Siège
21 des Mardelles
44 Rue Blaise Pascal
93600 AULNAY-SOUS-BOIS
Services Commerciaux
Phone 0 825 086 036
Telefax 0 825 086 346

Centre de formation
E-Mail : semin.sidonie@lenze.fr
Questions générales / documentation
E-Mail : info@lenze.fr

Service Après-vente / assistance en ligne
Helpline 24/24 : 0 825 826 117
E-Mail : helpline@lenze.fr

Agences en France
Région France Nord :
21 des Mardelles
44 Rue Blaise Pascal
93600 AULNAY-SOUS-BOIS

Nantes
44000 NANTES
Strasbourg
67870 GRIESHEIM près MOLSHEIM
Rouen
76500 ELBEUF

Région France Sud :
Parc Technologique
97, allée Alexandre Borodine
Immeuble le Douglas 2
69800 SAINT PRIEST

Agen
47270 SAINT-PIERRE de CLAIRAC

GREECE
GEORGE P. ALEXANDRIS SA
12, K. Mavromichali Street
18545 PIRAEUS
Phone +30 210 41 11 841
Telefax +30 210 41 27 058

Industrial Area, Block 48B, 4th Entrance
57022 SINDOS
Phone +30 2310 556 650
Telefax +30 2310 511 815

HUNGARY *
Lenze Hajtástechnika Kft
2040 BUDAÖRS
Gyár utca 2., P.O.Box 322.
Phone +36 (0)23 / 501-320
Telefax +36 (0)23 / 501-339

ICELAND
see DENMARK



INDIA

Lenze Mechatronics Pvt. Ltd.
Lenze Plot No. 46A, Sector-10
PCNTDA Industrial Area, Bhosari
PUNE - 411 026
Phone +91-20-66318100
Telefax +91-20-66318120

Kolkata Sales office
2nd Floor, 3/1 Ashton Road
KOLKATA - 700020
Phone +91-33-24190490
Telefax +91-33-24190562

New Delhi Sales office
Flat No - 101, Padma Tower - II
22, Rajendra Place
NEW DELHI - 110008
Phone +91-11-25812113/15
Telefax +91-11-25812114

INDONESIA

see MALAYSIA

IRAN

Tavan Ressian Co.
P.O.Box 19395-5177
No. 18, Sh. Bakhtiari Str.
South sh. Ghalandari Ave.
Sadr High way, TEHRAN
Phone +98-(21)-2260 6766
-2260 2655
-2260 9299
Telefax +98-(21)-2200 2883

ISRAEL *

Zeev Melcer LTD
P.O.B. 10011, HAIFA BAY 26110
36 Yosef Levi St., Kiriat Bialik
Phone +972-(0)4-8757037
Telefax +972-(0)4-8742172

ITALY *

Lenze Italia S.r.l.
Viale Monza 338, 20128 MILANO
Phone +39 02 / 270 98.1
Telefax +39 02 / 270 98 290

JAPAN *

Miki Pulley Co., Ltd.
1-39-7 Komatsubara, Zama-city
KANAGAWA 228-8577
Phone +81 (0)462 / 58 16 61
Telefax +81 (0)462 / 58 17 04

LATVIA

see LITHUANIA

LEBANON

I. Network Automation s.a.l.
Ground floor - United insurance building
Facing Mercedes Show room
Dora - High Way, BEIRUT-METEN
P.O.Box 835 - Jounieh - Lebanon
Phone +961-1-249562
Telefax +961-1-249563

LITHUANIA

Lenze UAB
Breslaujos g.3, 44403 KAUNAS
Phone +370 37 407174
Telefax +370 37 407175

LUXEMBOURG *

see BELGIUM

MACEDONIA

Lenze Antriebsstechnik GmbH
Pretstavništvo Skopje
ul. Nikola Rusinski 3/A/2, 1000 SKOPJE
Phone +389 2 30 90 090
Telefax +389 2 30 90 091

MALAYSIA

Lenze S.E.A. Sdn Bhd
No. 28 Jalan PJU 3/47
Sunway Damansara, Technology Park
47810 PETALING JAYA
SELANGOR DARUL EHSAN
Phone +60 3 7803 1428
Telefax +60 3 7806 3728

MAURITIUS

Automation & Controls Engineering Ltd
3, Royal Road, Le Hochet, Terre Rouge
MAURITIUS
Phone +230 248 8211
Telefax +230 248 8968

MEXICO

Sales:
see AMERICAS HQ

Service:
**Automatización y Control
de Energía S.A. de C.V.**
Av. 2 No.89 Esq Calle 13
Col. San Pedro de los Pinos
C.P. 03800 MEXICO D.F.
Phone +52 55 2636-3540
Fax +52 55 2636-3541

MOROCCO

GUORFET G.T.D.R
Automatisation Industrielle
Bd Chefchaouni Route 110 km, 11.500
No. 353-Ain-Sabaâ
CASABLANCA
Phone +212/22-35 70 78
Telefax +212/22-35 71 04

NETHERLANDS *

Lenze BV, Postbus 31 01
5203 DC 'S-HERTOGENBOSCH
Ploegweg 15
5232 BR 'S-HERTOGENBOSCH
Phone +31 (0)73 / 64 56 50 0
Telefax +31 (0)73 / 64 56 51 0

NEW ZEALAND *

Tranz Corporation
343 Church Street
P.O. Box 12-320, Penrose
AUCKLAND
Phone +64 (0)9 / 63 45 51 1
Telefax +64 (0)9 / 63 45 51 8

NORWAY *

Dtc- Lenze as
Stallbakken 5, 2005 RAEINGEN
Phone +47 / 64 80 25 10
Telefax +47 / 64 80 25 11

PHILIPPINES

see MALAYSIA

POLAND

Lenze Polska Sp. z o.o.
Ul. Rożdzeńskiego 188b
40-203 KATOWICE
Phone +48 (0) 32 203 97 73
Telefax +48 (0) 32 781 01 80

Torun Office
Lenze Polska Sp. z o.o.
Ul. Rydygiera 47
87-100 TORUN
Phone +48 (0) 56 658 28 00
Telefax +48 (0) 56 645 33 56

PORTUGAL *

Costa Leal el Victor
Electronica-Pneumatica, Lda.
Rua Prof. Augusto Lessa, 269,
Apart. 52053
4202-801 PORTO
Phone +351-22 / 5 50 85 20
Telefax +351-22 / 5 02 40 05

ROMANIA

see AUSTRIA

RUSSIA

OOO Lenze
Shchelkovskoye shosse 5
105122 MOSCOW
Phone +7 495 921 3250
Telefax +7 495 921 3259

SERBIA-MONTENEGRO

see MACEDONIA

SINGAPORE *

see MALAYSIA

SLOVAC REPUBLIC

ECS Sluzby spol. s.r.o.
Staromlynska 29
82106 BRATISLAVA
Phone +421 2 45 25 96 06
+421 2 45 64 31 47
+421 2 45 64 31 48
Telefax +421 2 45 25 96 06

SLOVENIA

LENZE GmbH, Asten, Avstrija
Podružnica Celje
Kidričeva 24
3000 CELJE
Phone +386 03 426 46 40
Telefax +386 03 426 46 50

SOUTH AFRICA *

S.A. Power Services (Pty.) Ltd.
Unit 14, Meadowbrook Business Estates
Jacaranda Ave, Olivedale
Randburg 2158, P.O.Box 1137
RANDBURG 2125
Phone +27(11) 462-8810
Telefax +27(11) 704-5775

SOUTH KOREA *

Lenze Representative Office
No. 606, Daeryung Technotown 6th,
493-6, Gasan-dong, Geumcheon-gu,
SEOUL 153-774
Phone +82 2-792-7017
Telefax +82 2-792-7018

SPAIN *

Lenze Transmisiones, S.A. (Headquarter)
Edificio TCA
Henri Dunant, 9. Planta baja
08173 SANT CUGAT DEL VALLES
Barcelona
Phone +34 902 02 79 04
Telefax +34 902 02 63 69

Lenze Delegación Norte
Phone +34 944 630 510 / 507
Telefax +34 944 314 196

Lenze Delegación Levante
Cullera, 73 - 4ºD
46035 BENIMAMET
Valencia
Phone +34 902 027 904
Telefax +34 902 026 369

Lenze Delegación Madrid
Poema Sinfónico Nº 25-27
Esc. 1, Pfta. B, Loc. 3
28054 MADRID
Phone +34 915 103 341
Telefax +34 915 102 061

SWEDEN *

Lenze Transmissioner AB
P.O.Box 10 74, Attorpsgatan, Tornby Ind.
58110 LINKÖPING
Phone +46 (0)13 / 35 58 00
Telefax +46 (0)13 / 10 36 23

SWITZERLAND *

Lenze Bachofen AG
Ackerstrasse 45
8610 USTER
Phone +41 (0) 43 399 14 14
Telefax +41 (0) 43 399 14 24

Vente Suisse Romande:
Route de Prilly 25
1023 CRISSIER
Phone +41 (0)21 / 63 72 19 0
Telefax +41 (0)21 / 63 54 76 2

SYRIA

Zahabi Co.
8/5 Shouhadadaa Street
P.O.Box 8262
ALEPPO-SYRIA
Phone +963 21 21 22 23 5
Telefax +963 21 21 22 23 7

TAIWAN *

Lenze Taiwan Representative Office
6F-1, No.136, Sec. 3, Zhongxiao E. Rd.
TAIPEI City, 10655, Taiwan
Phone +886 / (0)2-2721-2161
Telefax +886 / (0)2-2721-2706

THAILAND

see MALAYSIA

TUNESIA

AMF Industrielle Sarl
Route de Gremda - Km 0,2
Immeuble El Madina,
Centre Bloc B - 5 ème - appt 52
3002 SFAX
Phone +216 74 403 514
Telefax +216 74 402 516

TURKEY

LSE Elektrik
Elektronik Makina
Otomasyon Mühendislik
Sanayi ve Ticaret Ltd. Şti
Atatürk mah. Cumhuriyet cad.
Yurt sok. No: 7
ÜMRANIYE/İSTANBUL
Phone +90 (0)216 / 316 5138 pbx
Telefax +90 (0)216 / 443 4277

UKRAINE

SV Altera, Ltd.
Lepse ave., 4
KIEV, 03067
Phone +38 044 496 18 88
Telefax +38 044 496 18-18

UNITED ARAB EMIRATES

LPT (FZC)
X4 Building No. 37
Sharjah Airport Free Zone (SALF ZONE)
SHARJAH
Phone +971 6 5573205
Telefax +971 6 5573206

UNITED KINGDOM/EIRE *

Lenze Ltd.
Fraser Road
Priory Business Park
BEDFORD MK44 3WH
Phone +44 (0)1234 / 75 32 00
Telefax +44 (0)1234 / 75 32 20

USA *

AMERICAS HQ
Lenze Americas Corporation
630 Douglas Street
UXBRIDGE, MA 01569
Phone +1 508 278 9100
Telefax +1 508 278 7873

Sales:
see Americas HQ

Operations:
Lenze AC Tech Corporation
630 Douglas Street
UXBRIDGE, MA 01569
Phone +1 508 278 9100
Telefax +1 508 278 9294

Lenze DETO Drive Systems
see Americas HQ

VIETNAM

see MALAYSIA

* Countries connected to the free expert helpline 008000 24 hours (008000 24 46877)

It's good to know | why we are there for you



"Our customers come first. Customer satisfaction is what motivates us. By thinking in terms of how we can add value for our customers we can increase productivity through reliability."



"We will provide you with exactly what you need – perfectly co-ordinated products and solutions with the right functions for your machines and installations. That is what we mean by 'quality'."



"Take advantage of our wealth of expertise. For more than 60 years now we have been gathering experience in various fields and implementing it consistently and rigorously in our products, motion functions and pre-configured solutions for industry."



"The world is our marketplace. Wherever you are in the world, we are nearby, providing you with our drive and automation solutions."

Algeria · Argentina · Australia · Austria · Belarus · Belgium · Bosnia-Herzegovina · Brazil · Bulgaria · Canada · Central America · Chile · China · Colombia · Croatia · Czech Republic · Denmark · Egypt · Estonia · Finland · France · Germany · Greece · Hungary · Iceland · India · Indonesia · Iran · Israel · Italy · Japan · Latvia · Lebanon · Lithuania · Luxembourg · Macedonia · Malaysia · Mauritius · Mexico · Morocco · Netherlands · New Zealand · Norway · Philippines · Poland · Portugal · Romania · Russia · Serbia-Montenegro · Singapore · Slovak Republic · Slovenia · South Africa · South Korea · Spain · Sweden · Switzerland · Syria · Taiwan · Thailand · Tunisia · Turkey · Ukraine · United Arab Emirates · United Kingdom/Eire · USA · Vietnam

You can rely on our service. Expert advice is available 24 hours a day, 365 days a year, in more than 30 countries via our international helpline: 008000 24 Hours (008000 2446877).